

METIGLA 

smart covering. simply passion.

Installatiegids
BIMODULAIR



Profiel **ELIT**

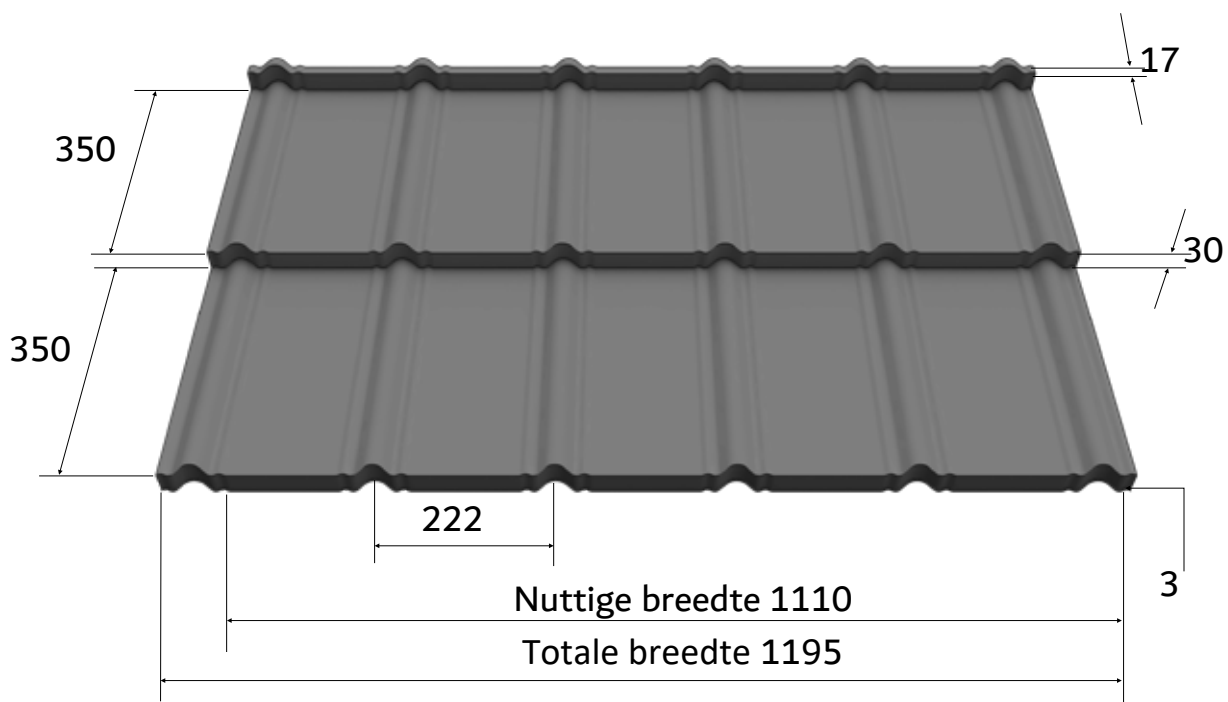

Profiel **SAGA**

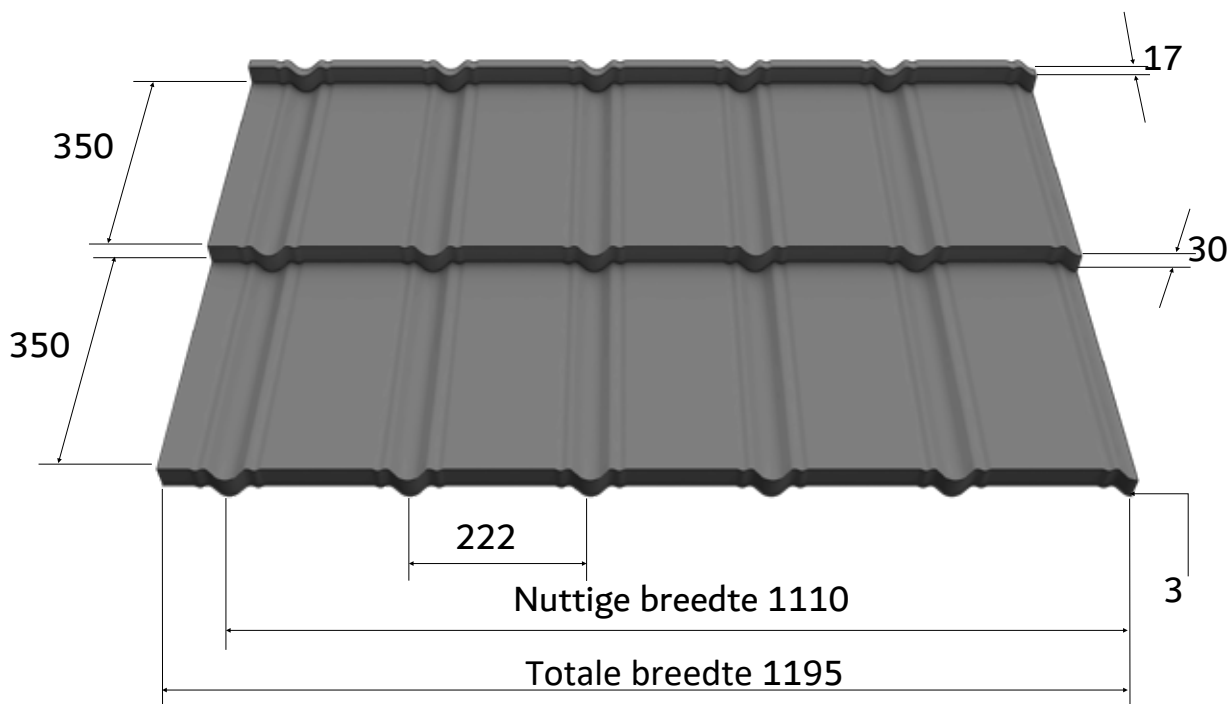



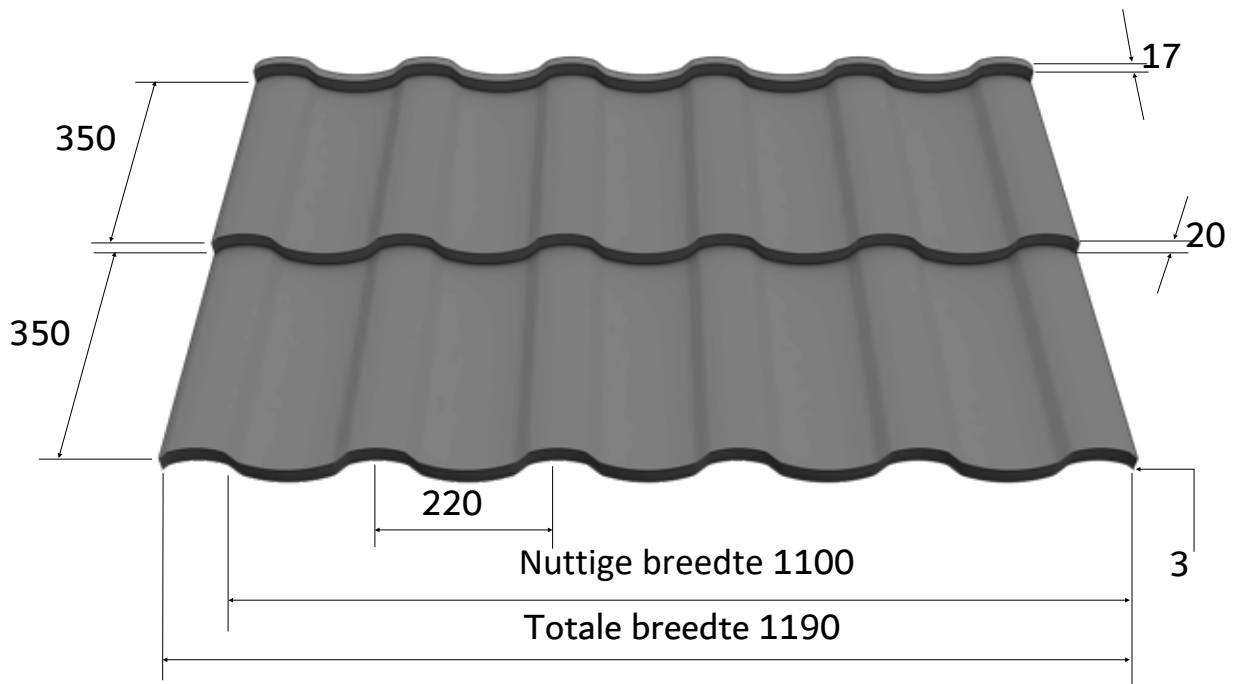



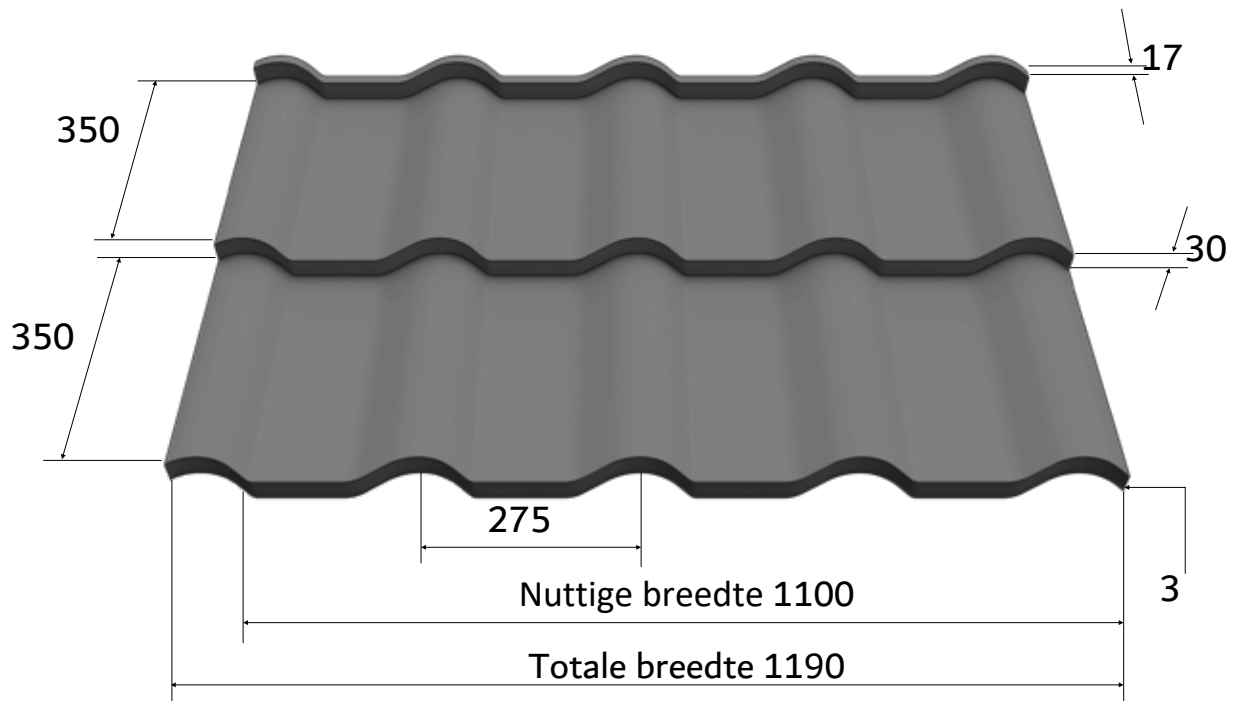



Profiel STAR

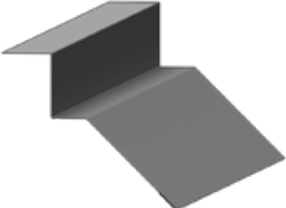





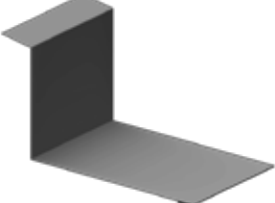
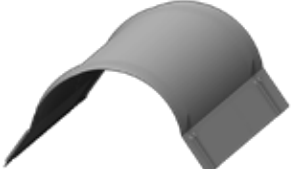
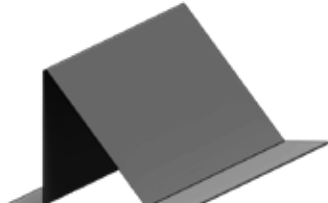

Profiel MIRA



Afwerkingstukken

<p>Verlenging druiplijst</p>  A vertical, L-shaped metal profile with a flat top surface and a vertical side flange.	<p>Druiplijst</p>  A metal profile with a wide, flat top surface and a vertical side flange, designed for water runoff.
<p>Gootslab</p>  A metal profile with a wide, flat top surface and a vertical side flange, designed for gutter installation.	<p>Interne windveer Sinus</p>  A metal profile with a corrugated top surface and a vertical side flange.
<p>Versterkte windveer</p>  A metal profile with a wide, flat top surface and a vertical side flange, designed for reinforcement.	<p>Verlenging windveer</p>  A vertical, L-shaped metal profile with a flat top surface and a vertical side flange.
<p>Kilgoot</p>  A metal profile with a wide, flat top surface and a vertical side flange, designed for gutter installation.	<p>Interne windveer</p>  A metal profile with a wide, flat top surface and a vertical side flange.
<p>Nokplaat tegen muur</p>  A metal profile with a wide, flat top surface and a vertical side flange, designed for roof edge protection.	<p>Ronde nokplaat</p>  A metal profile with a curved top surface and a vertical side flange.
<p>Sneeuwstopper</p>  A metal profile with a wide, flat top surface and a vertical side flange, designed for snow protection.	<p>Sneeuwstopper Omega</p>  A metal profile with a wide, flat top surface and a vertical side flange, designed for snow protection.

Benodigde gereedschappen

<p>Blikschaar</p> 	<p>Plooitang</p> 
<p>Meter</p> 	<p>Hamer</p> 
<p>Afstandhouder (Fig. 1)</p> 	<p>Schroefmachine</p> 

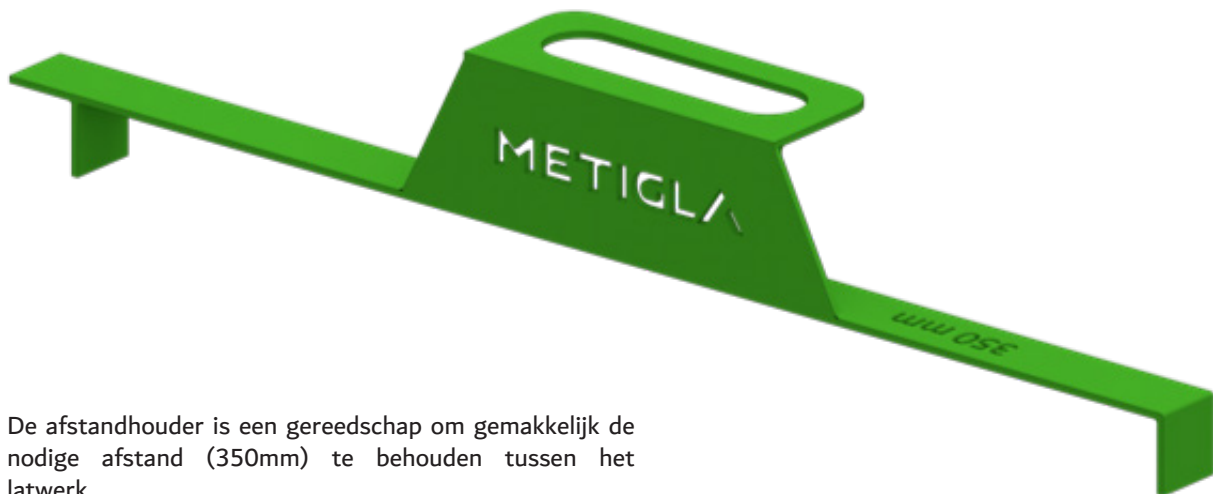

De afstandhouder is een gereedschap om gemakkelijk de nodige afstand (350mm) te behouden tussen het latwerk.

Fig. 1

Het is verboden om de platen te snijden met een (haakse) slijper of ander gereedschap dat voor plaatselijke verhitting van het plaatwerk zorgt. Bij gebruik hiervan vervalt automatisch uw garantie op het product



Controleer uw dakstructuur

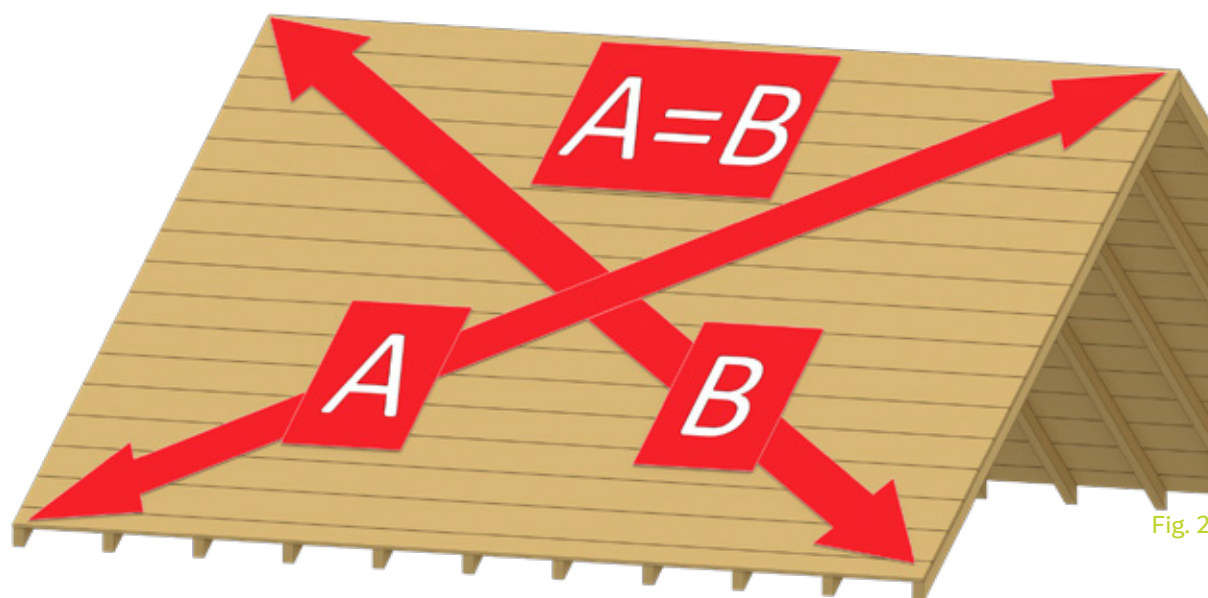

Fig. 2

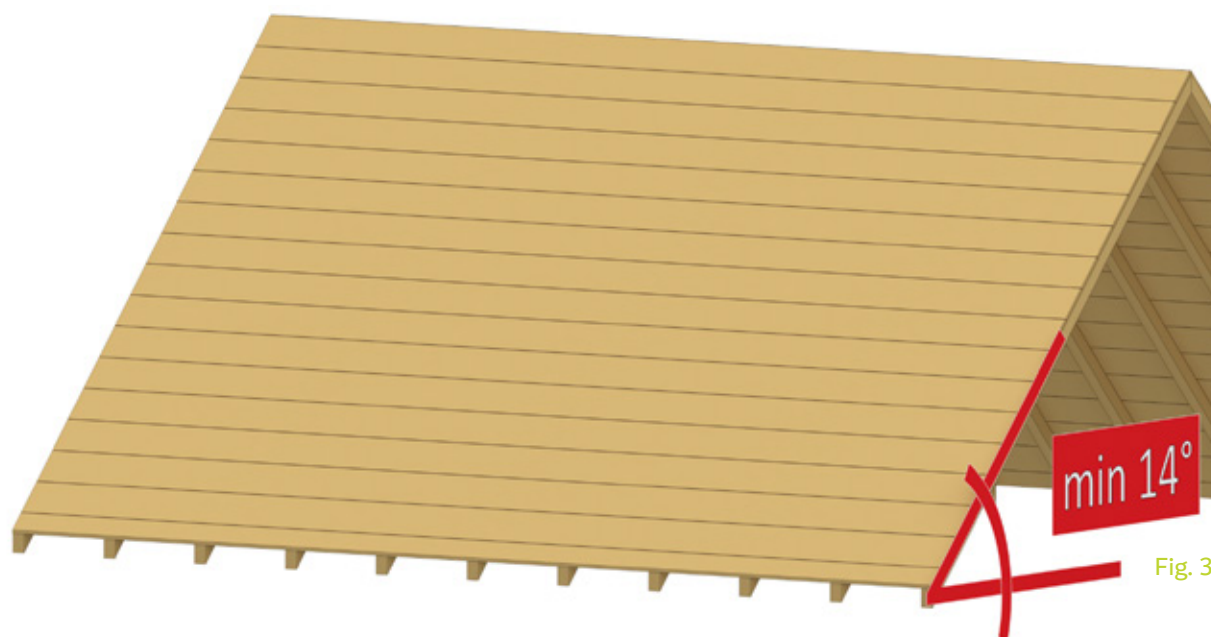

Fig. 3

Plaatsen druiplijst

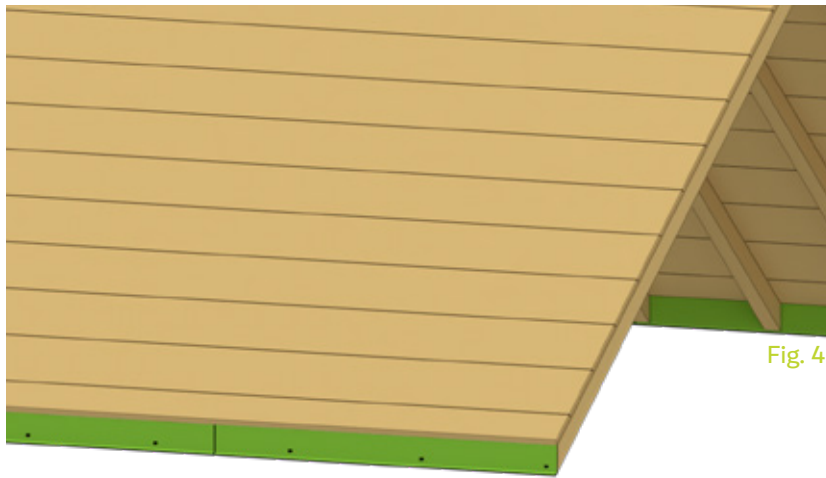
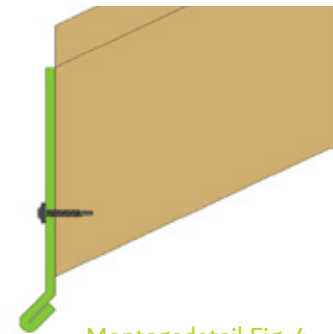

Fig. 4



Montagedetail Fig. 4

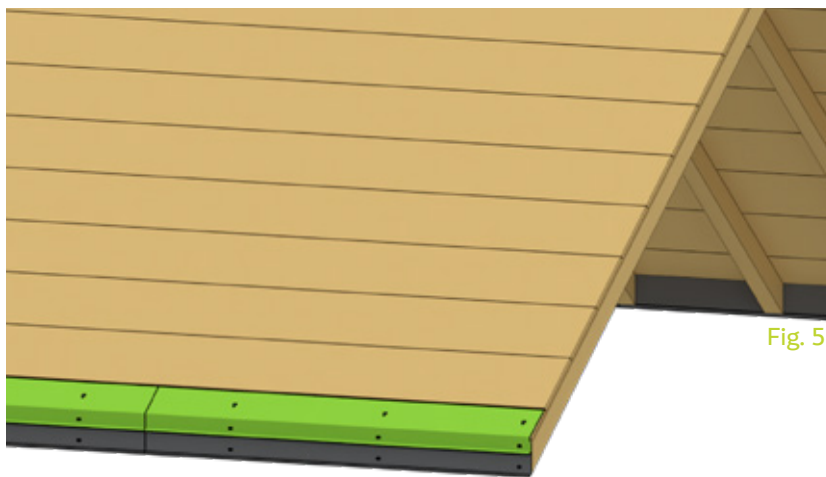
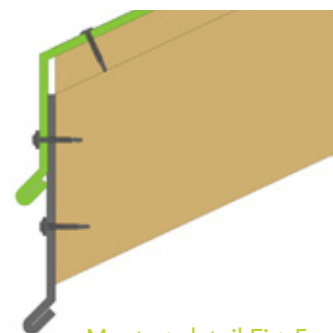

Fig. 5



Montagedetail Fig. 5

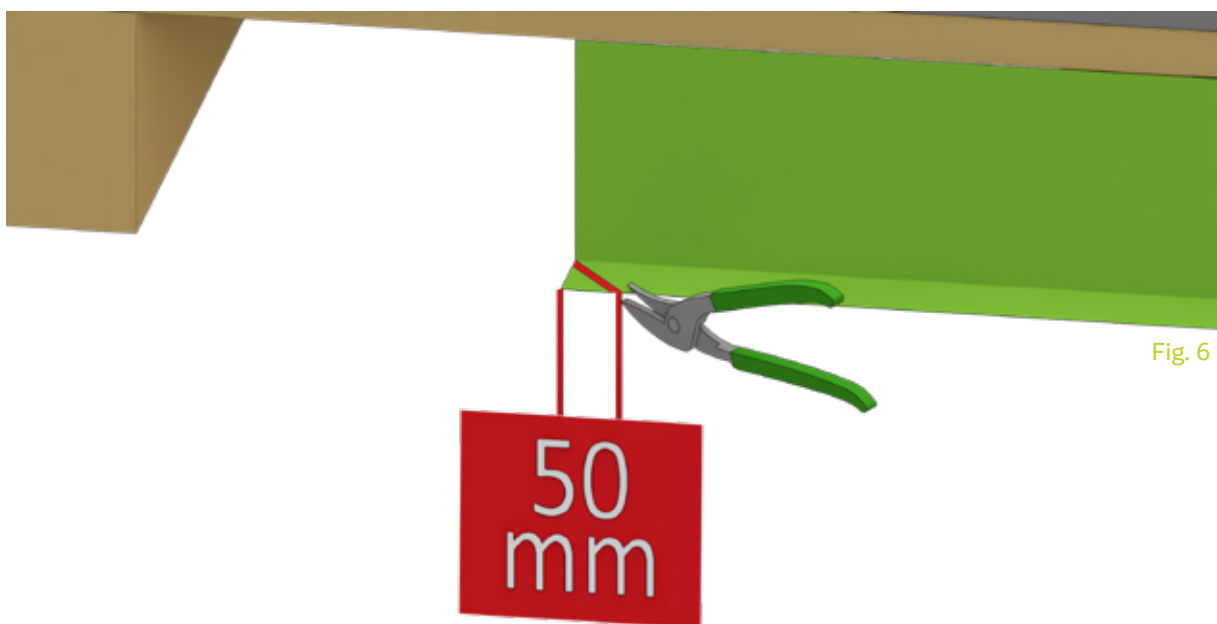

Fig. 6

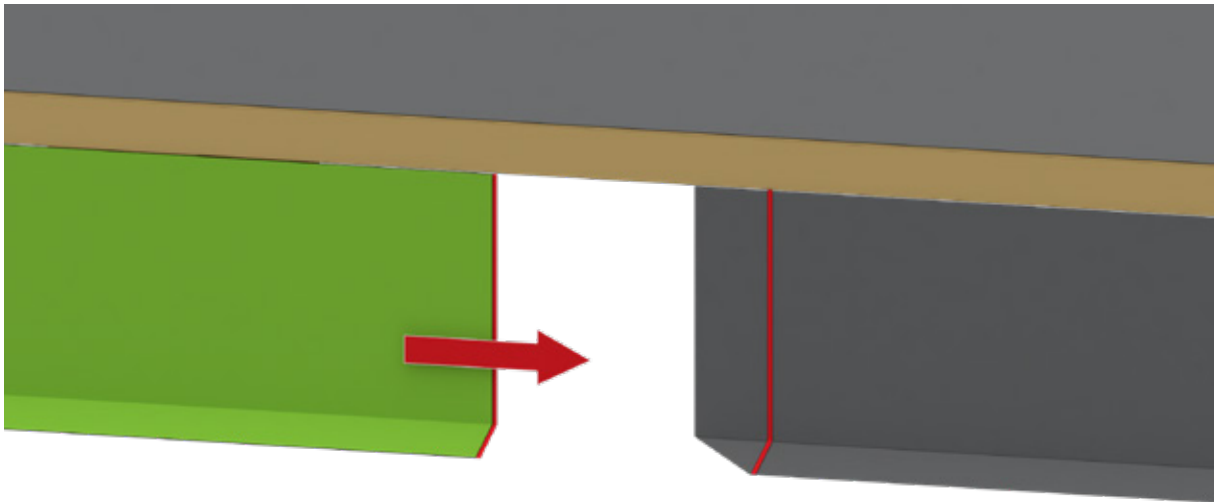

Fig. 7

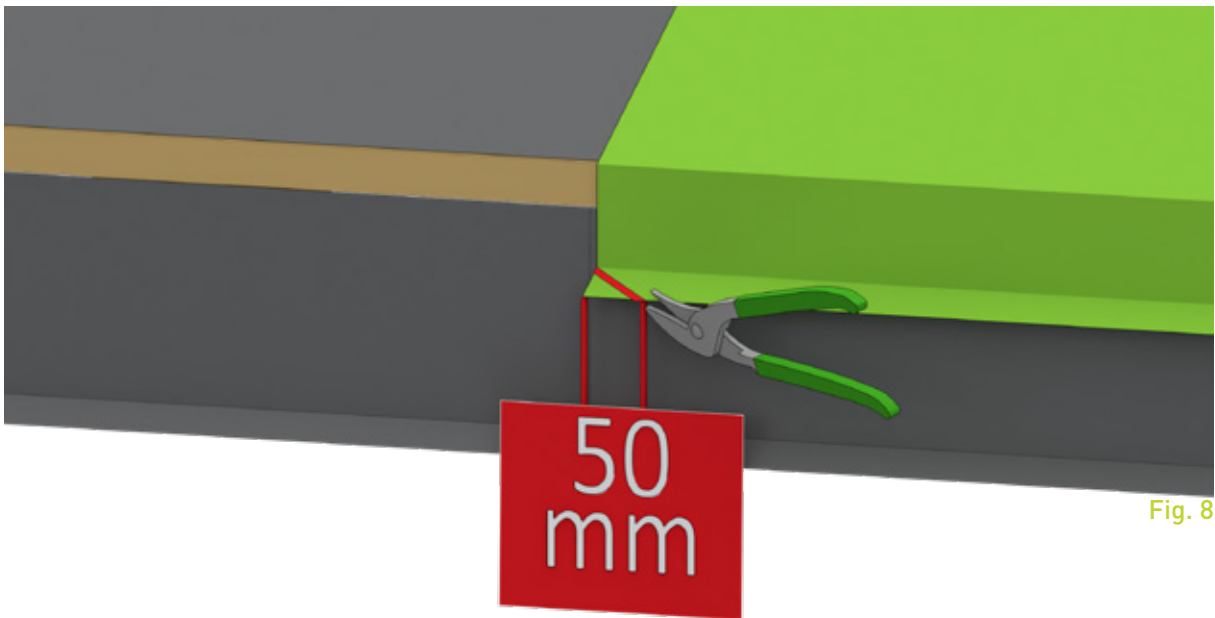

Fig. 8

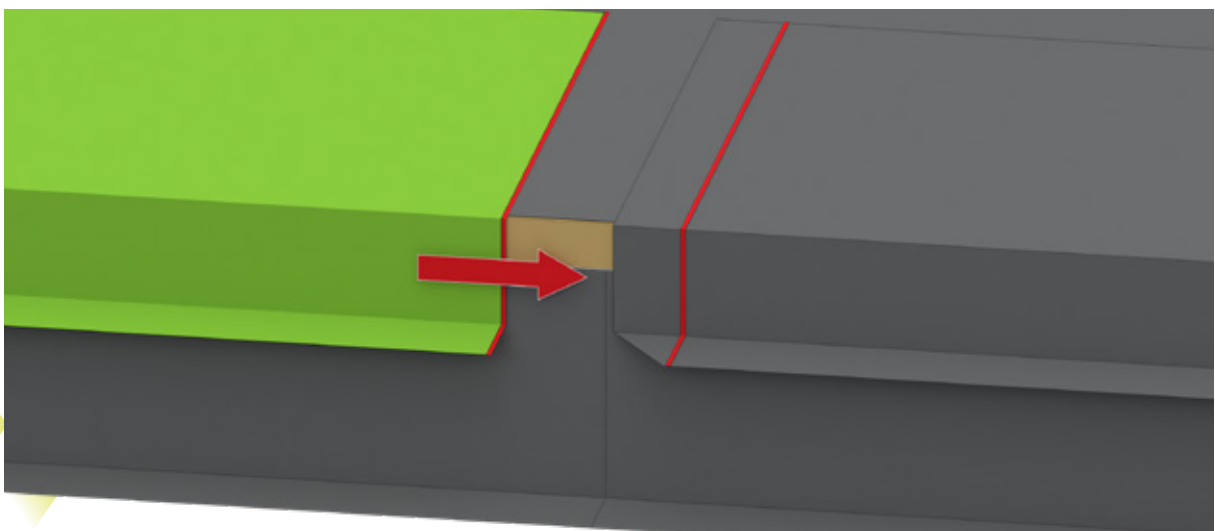

Fig. 9

Plaatsen onderdakfolie

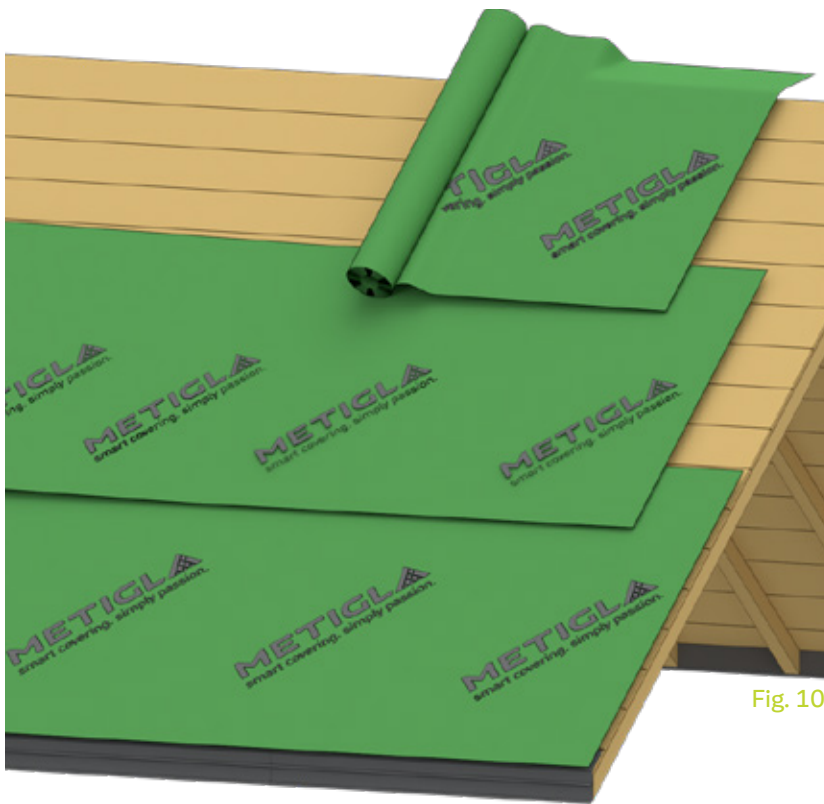
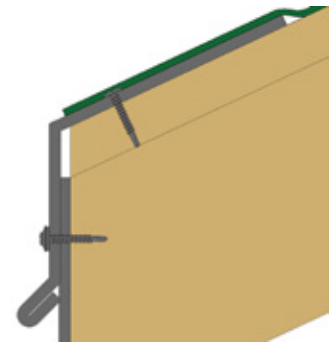

Fig. 10



Montagedetail Fig. 10



Fig. 11

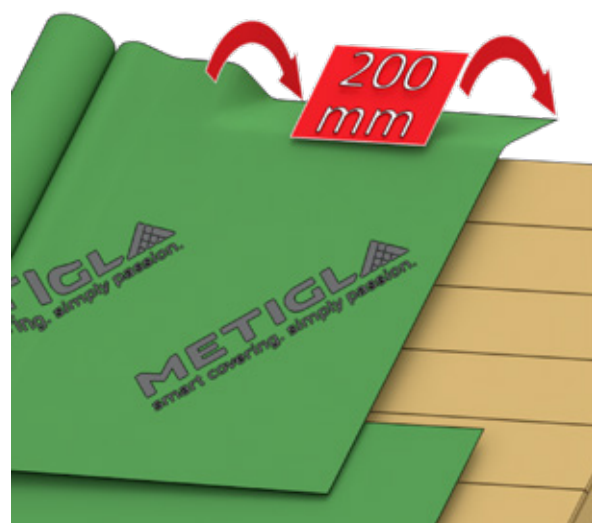

Fig. 12

Vorbereitung dakspanten voor plaatsing van de goothaken en het aanbrengen van het ventilatienet

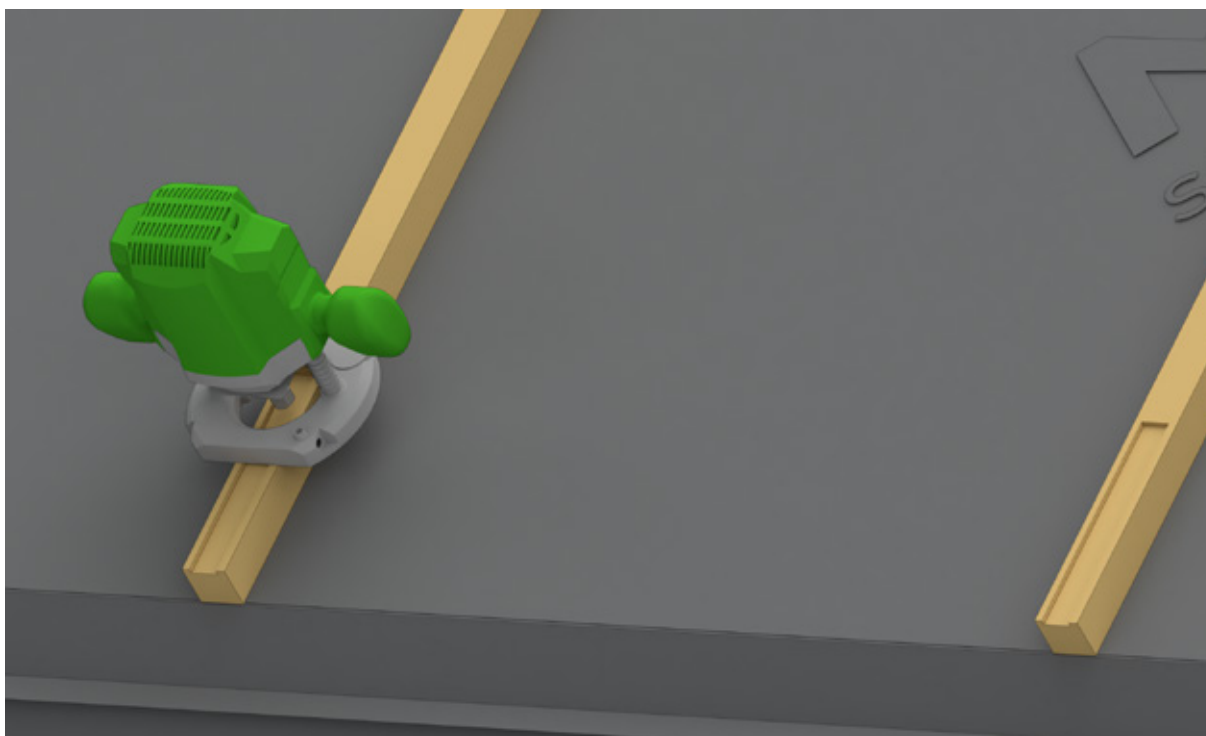

Fig. 13

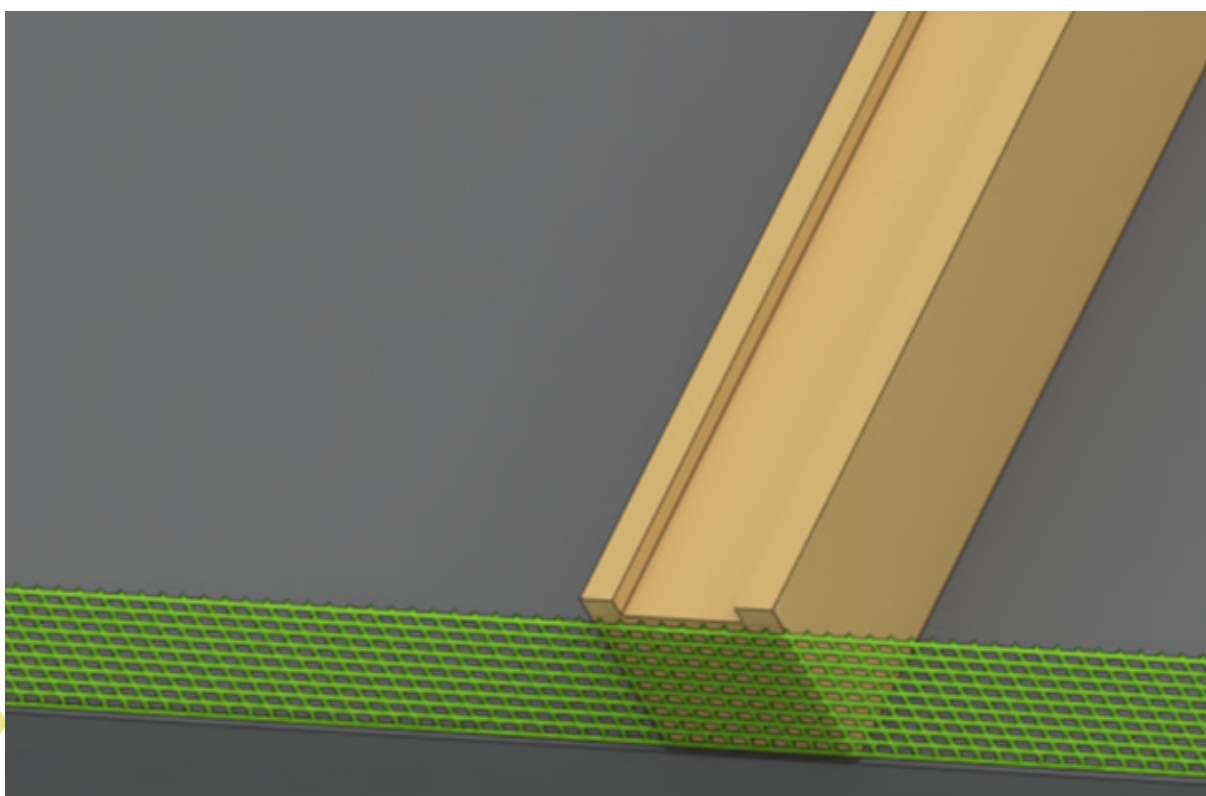
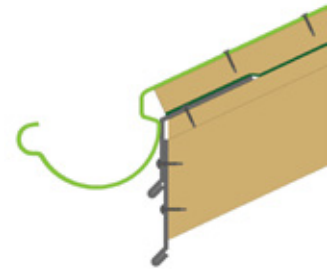

Fig. 14

Plaatsen goothaken en goot



Fig. 15



Montagedetail Fig. 15

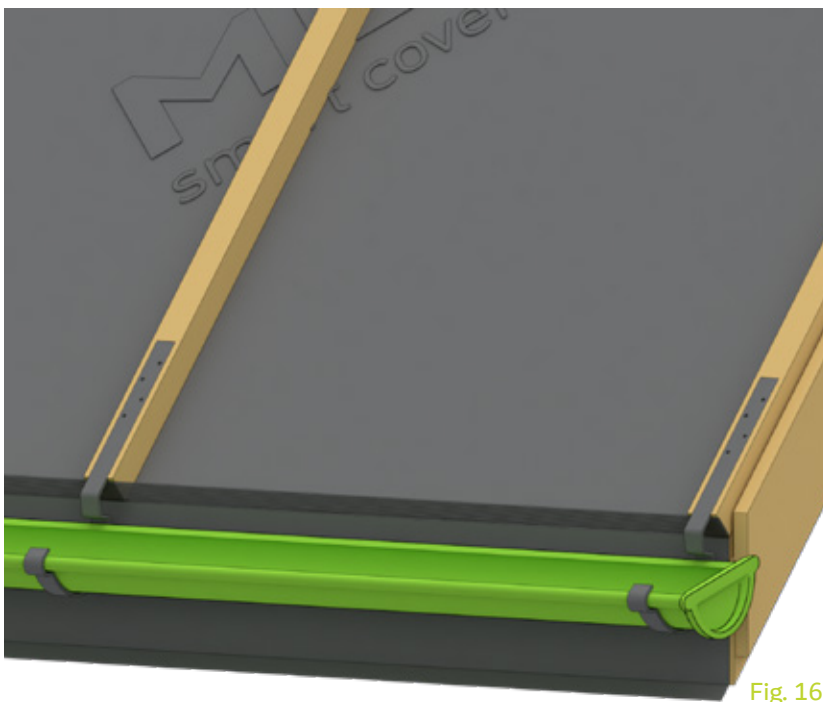

Fig. 16



Montagedetail Fig. 16

Plaatsen latwerk

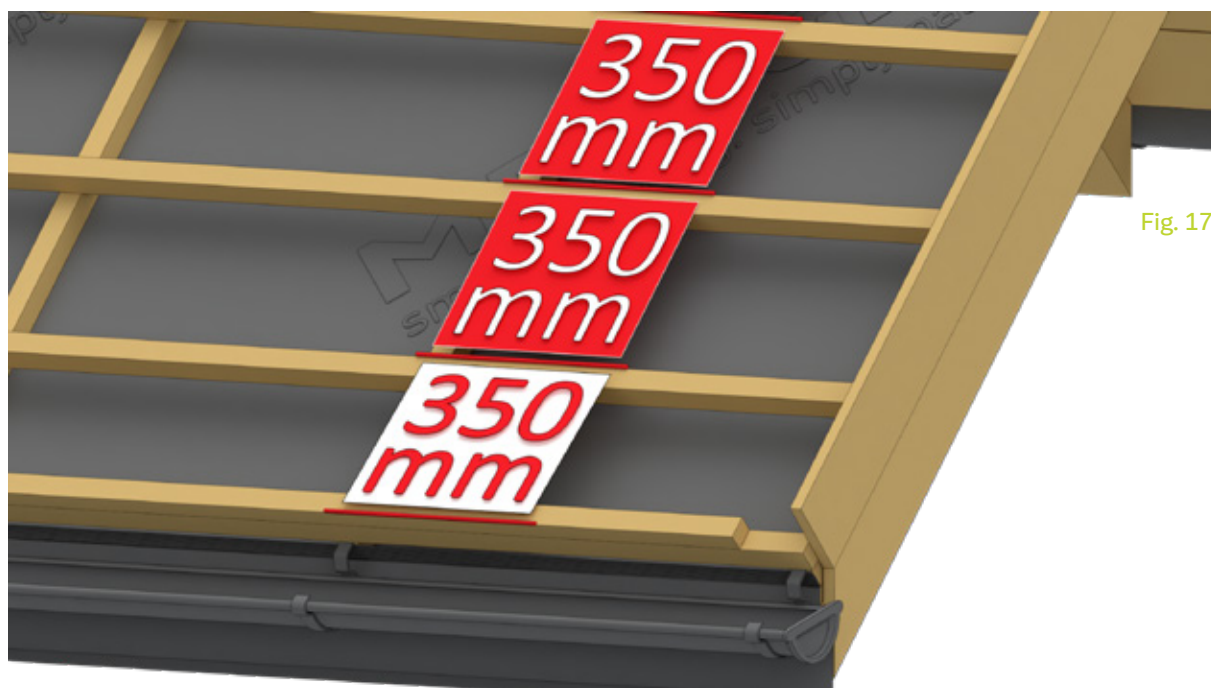

Fig. 17

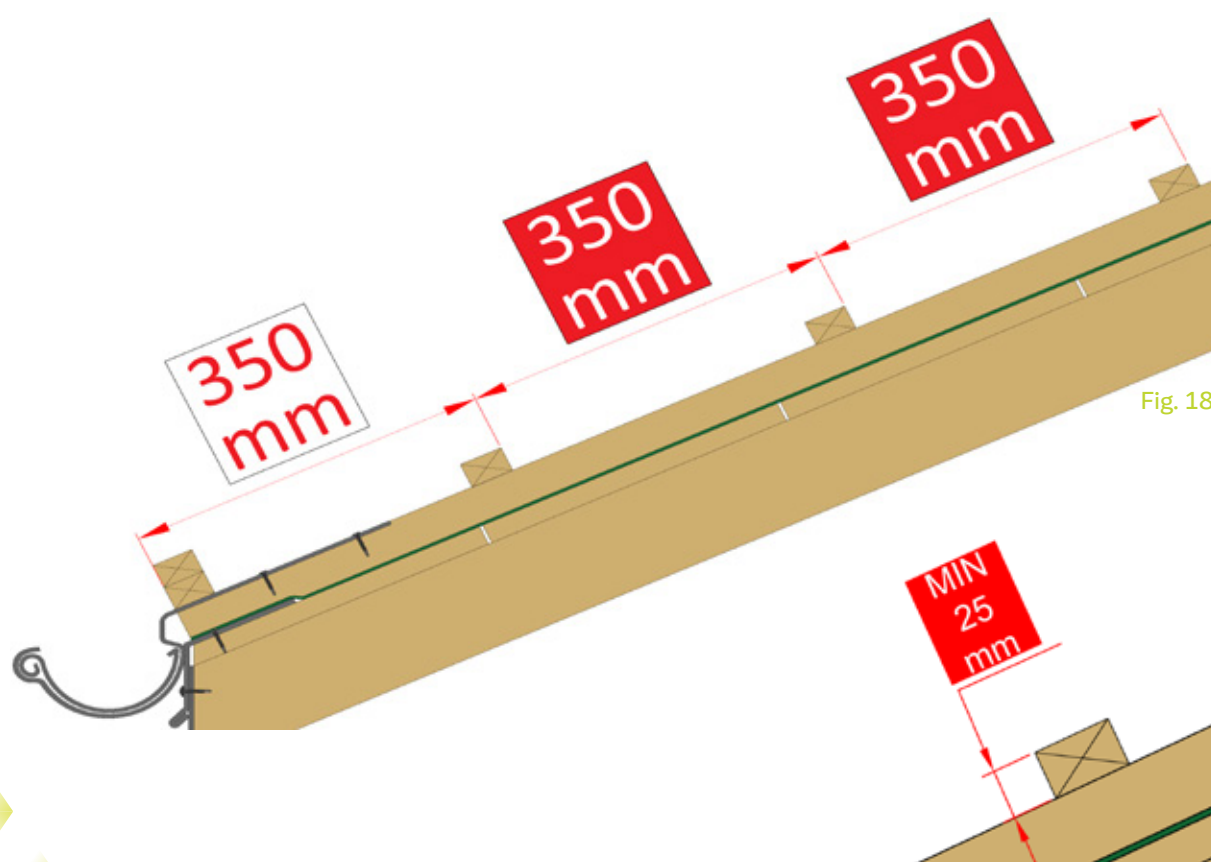

Fig. 18

Montagedetail Fig. 18

Voorbereiden en plaatsen gootslab

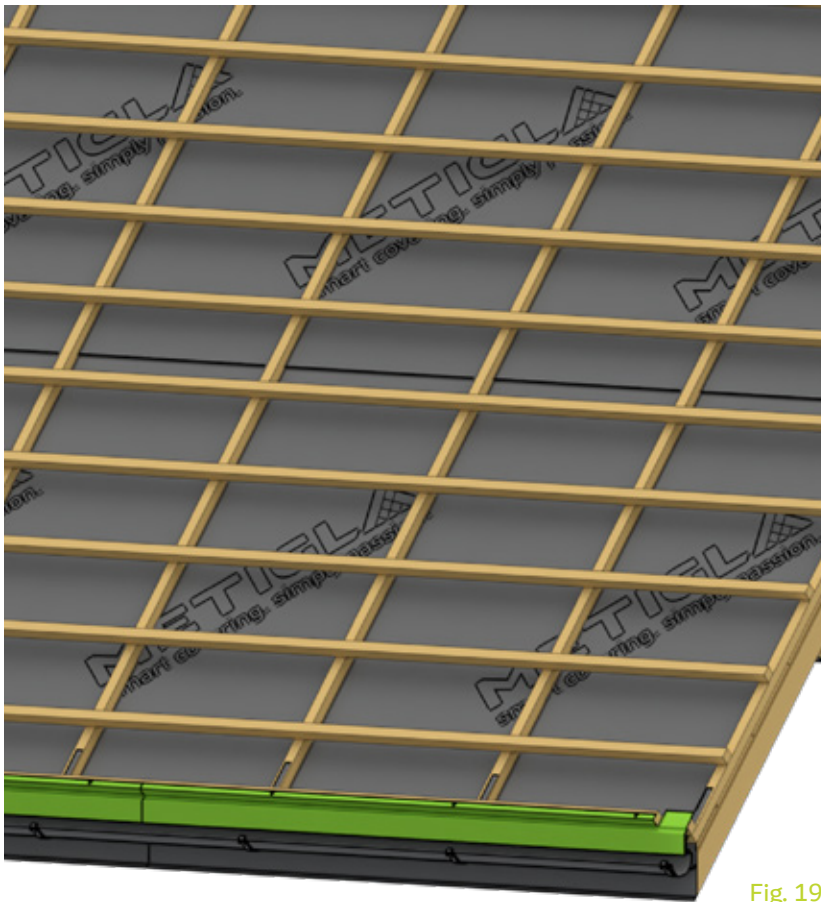

Fig. 19



Montagedetail Fig. 19

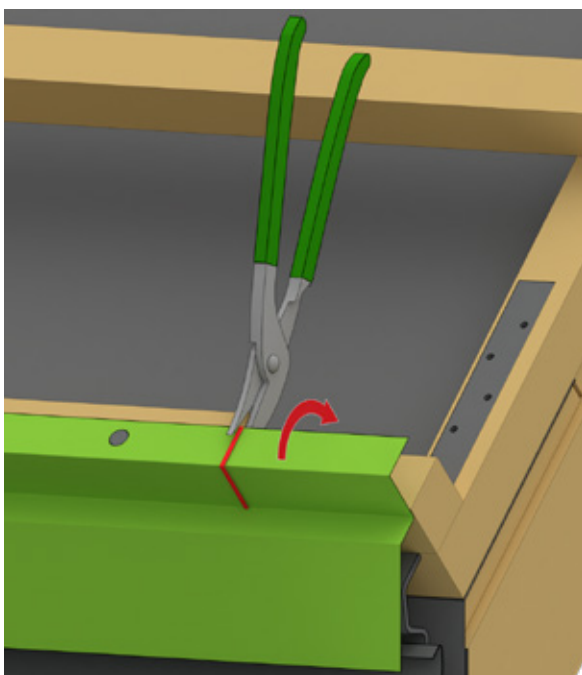

Fig. 20

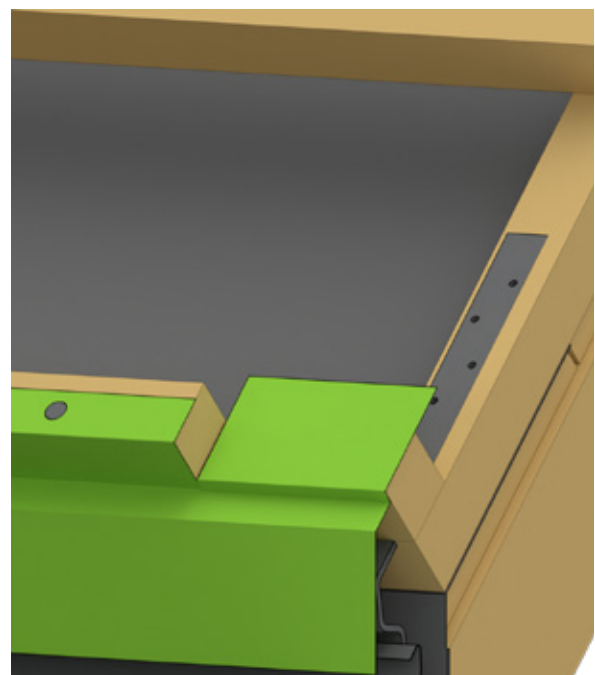

Fig. 21

Vorbereiden kilgoot

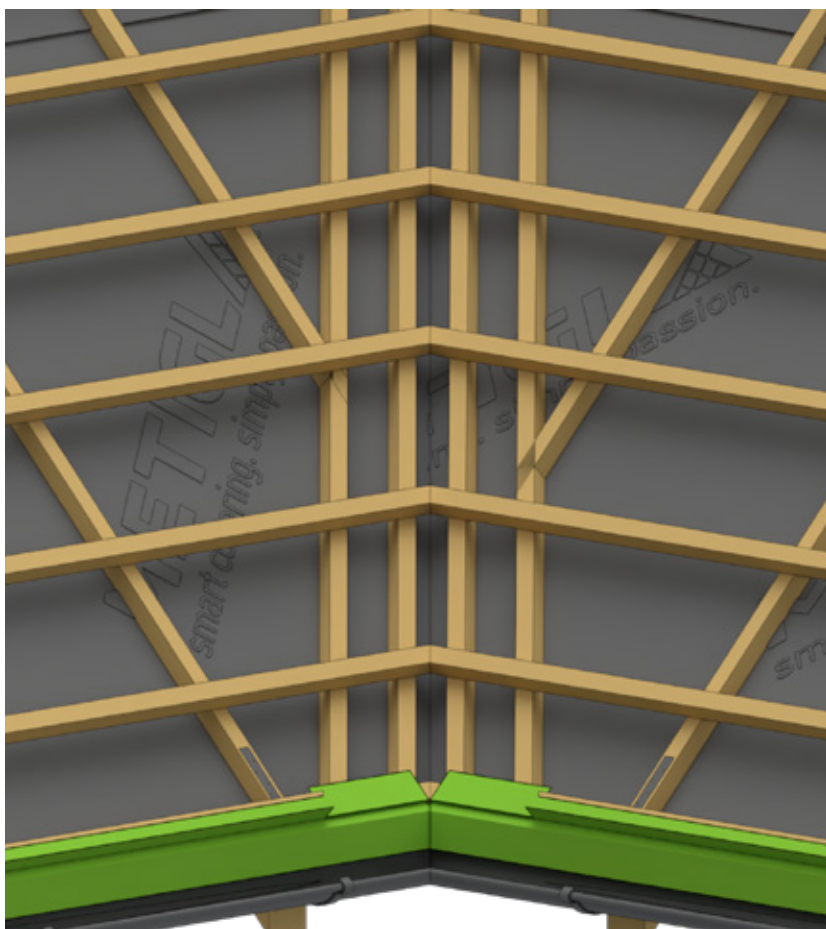
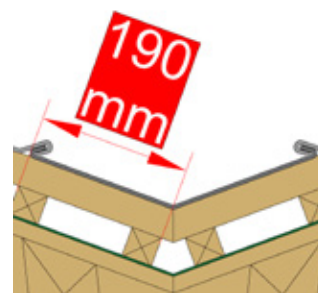

Fig. 22



Montagedetail Fig. 22

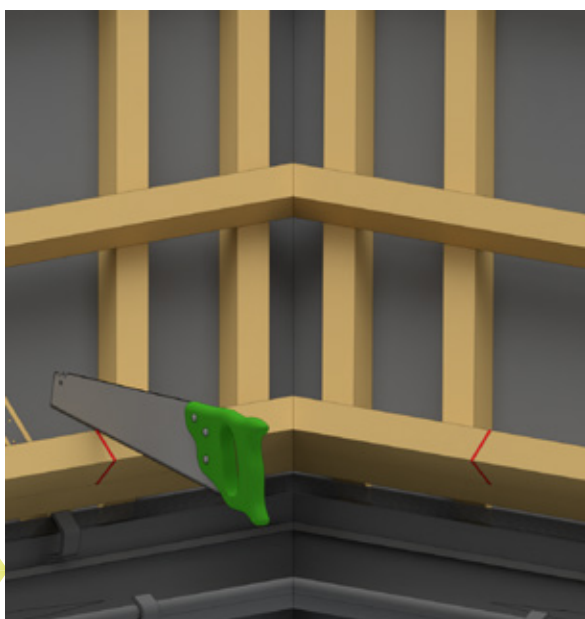

Fig. 23

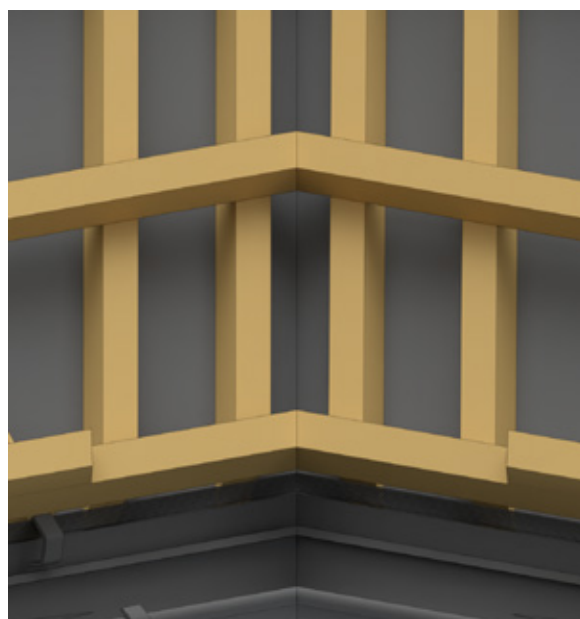

Fig. 24

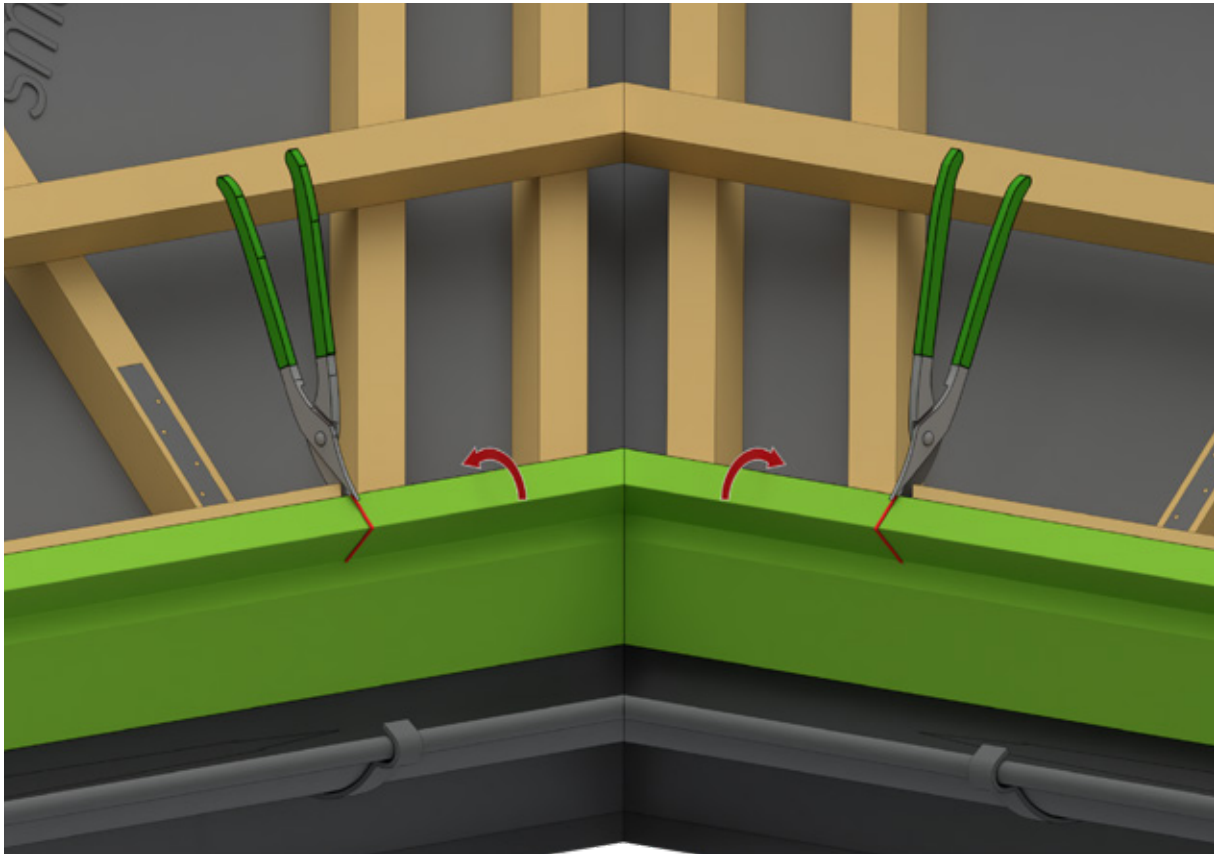

Fig. 25

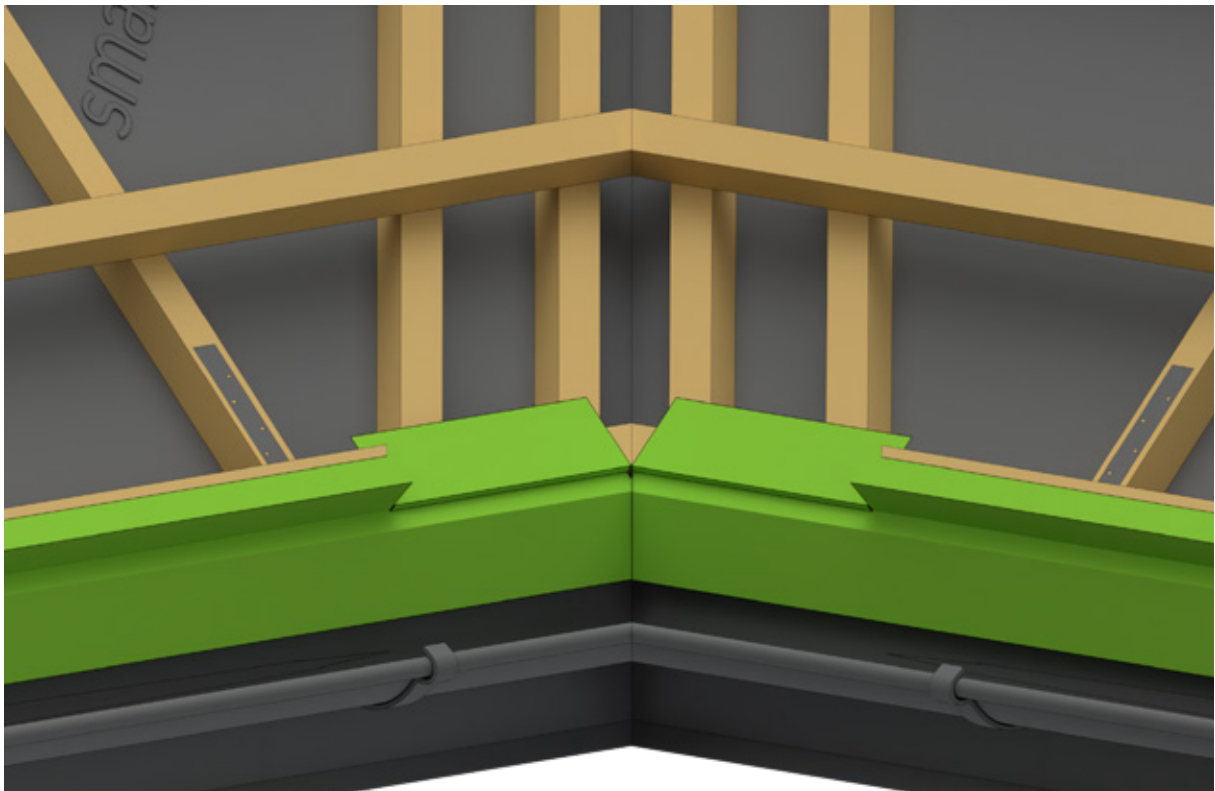

Fig. 26

WINDVEER - VARIANT 1 Interne windveer sinus

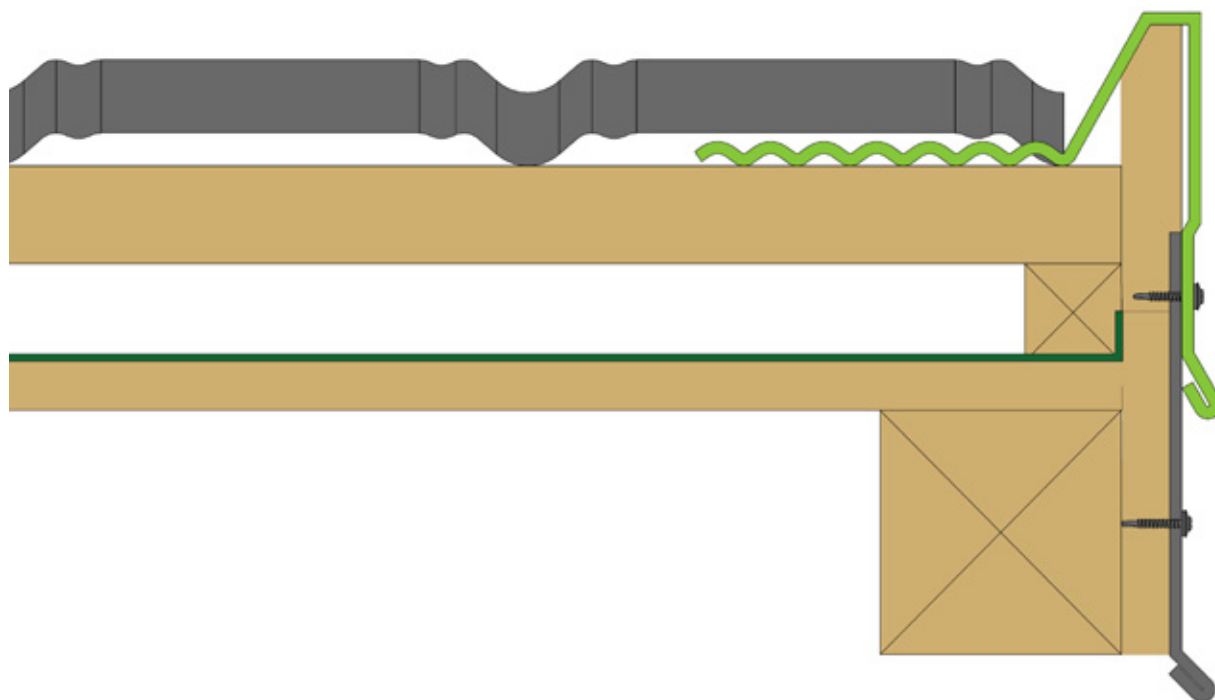

Fig. 27

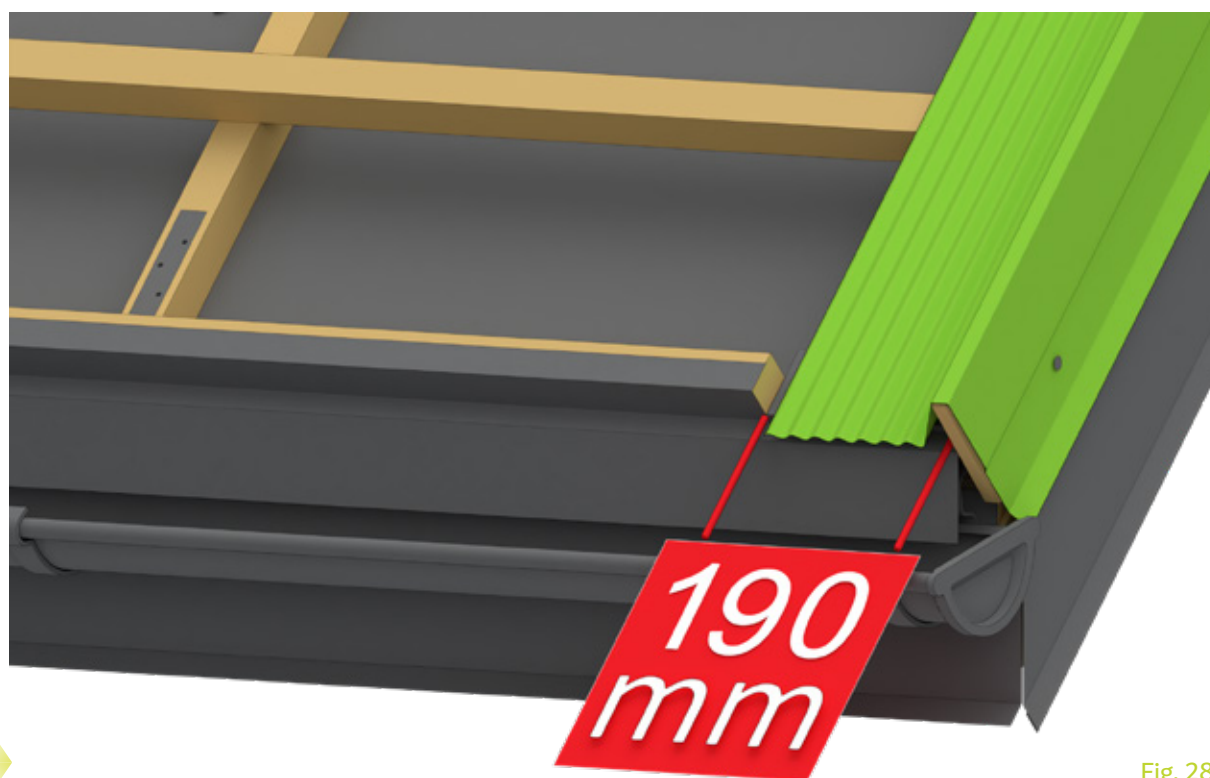

Fig. 28

WINDVEER - VARIANT 2

Windveer met interne windveer

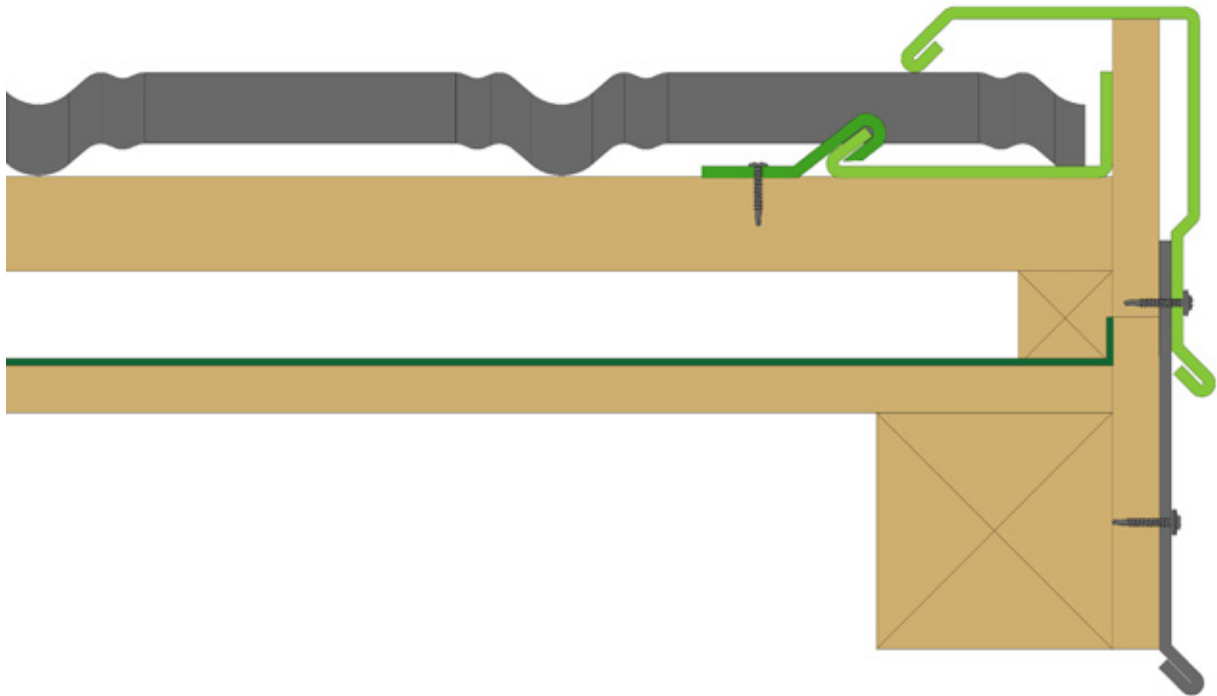

Fig. 29

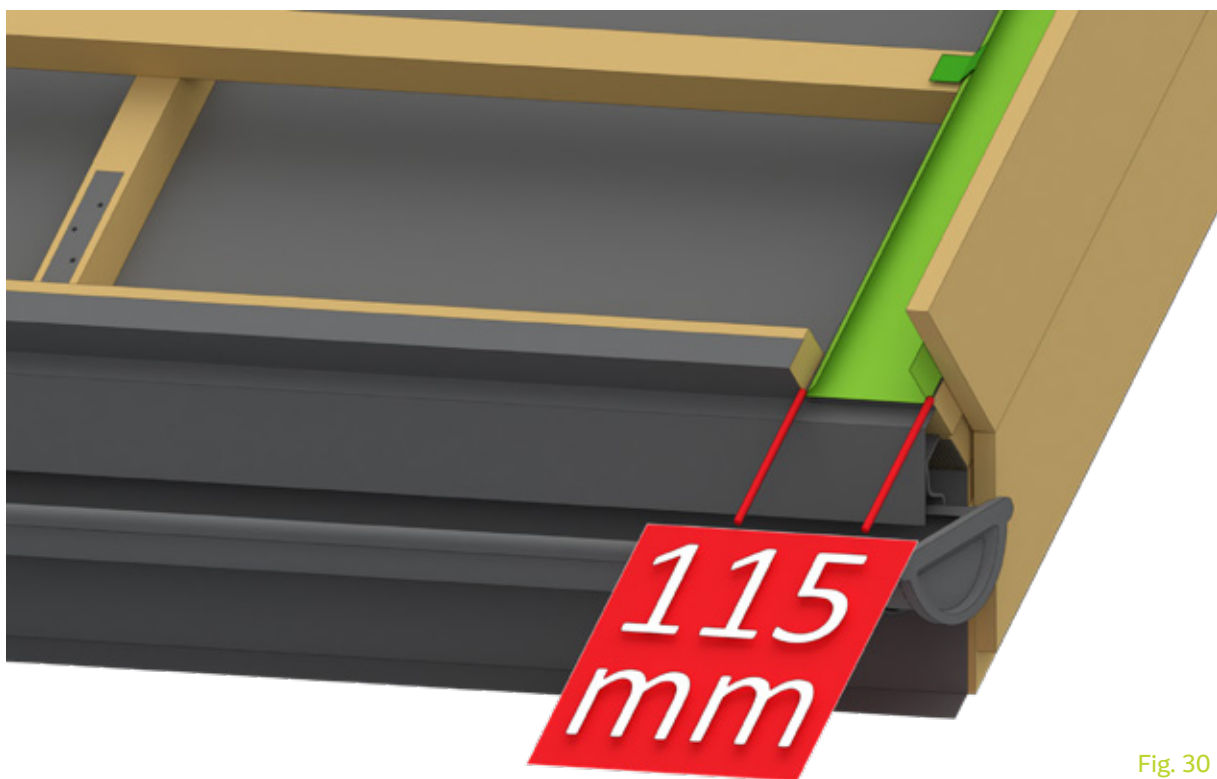

Fig. 30

Plaatsen muurverbinding

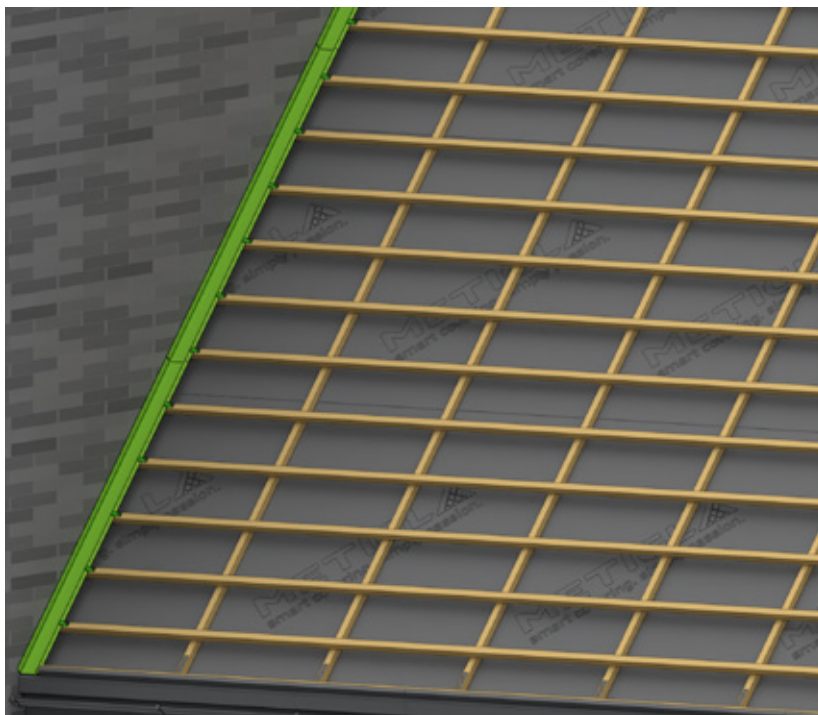
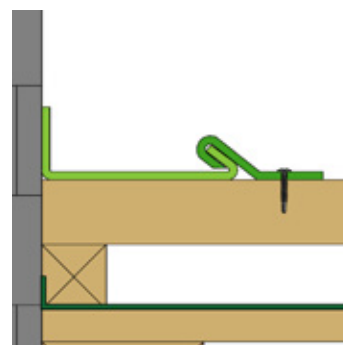

Fig. 31



Montagedetail Fig. 31

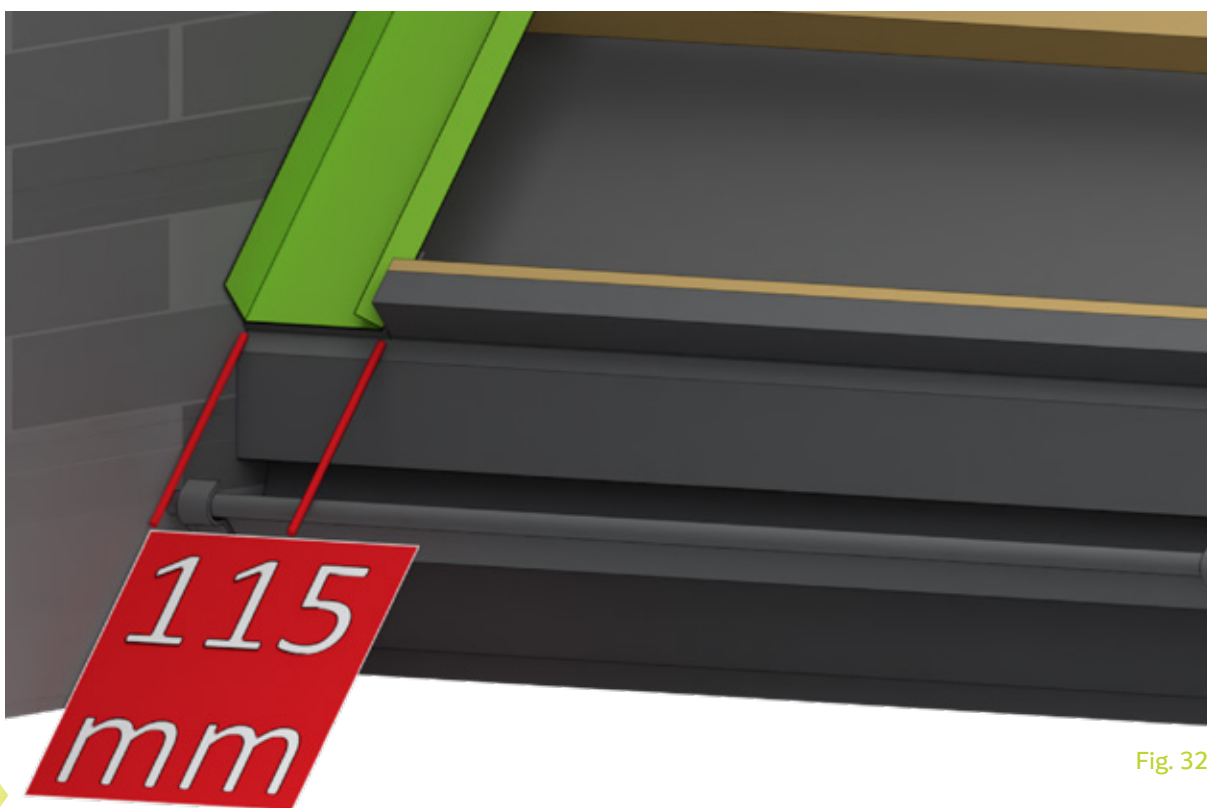

Fig. 32

Plaatsen kilgoot

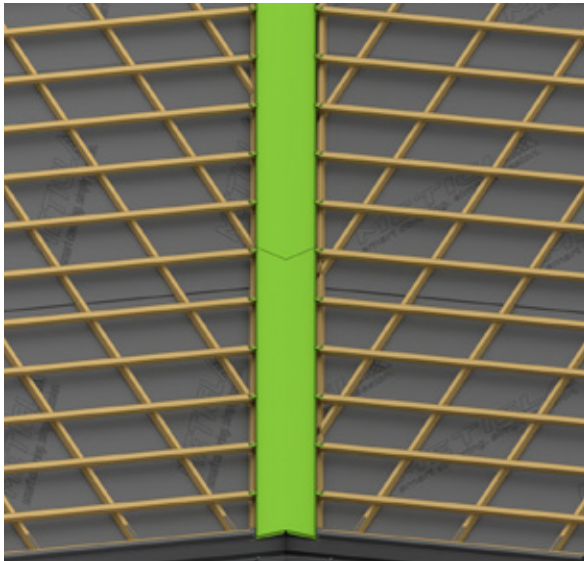

Fig. 33

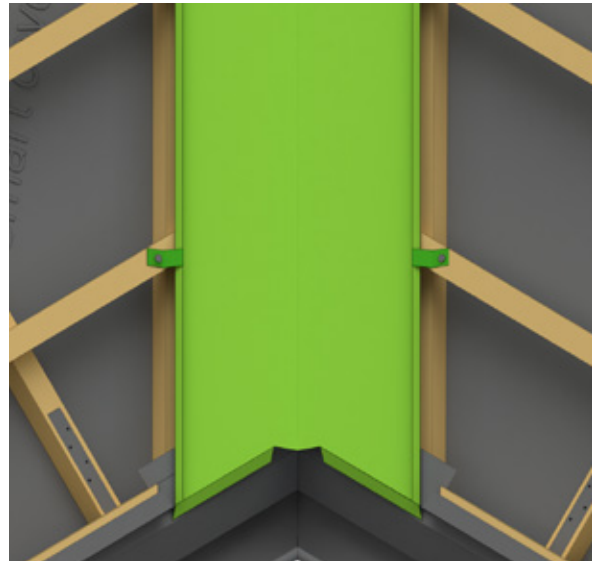

Fig. 34



Fig. 35

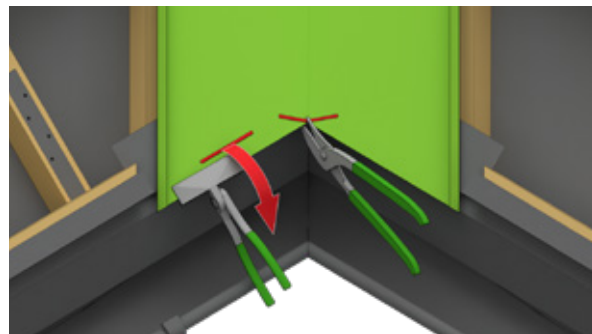

Fig. 36

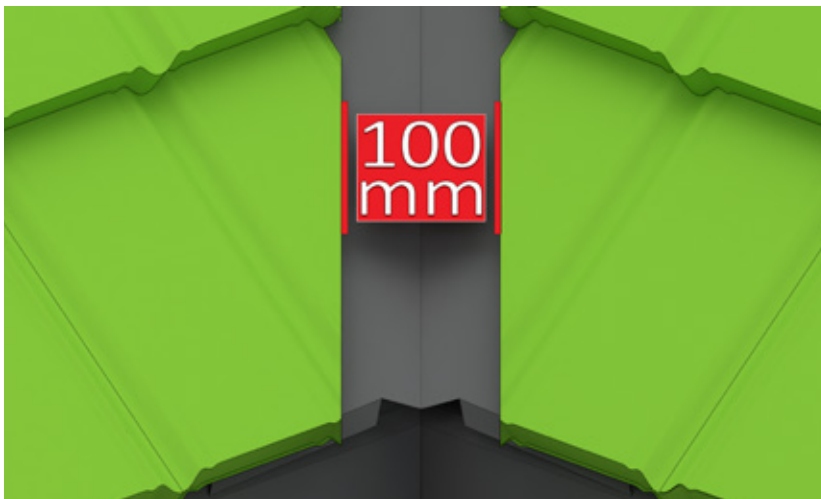
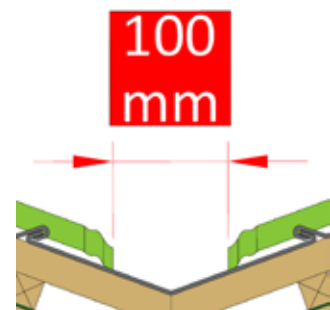

Fig. 37



Montagedetail fig. 37

Plaatsen dakplaten

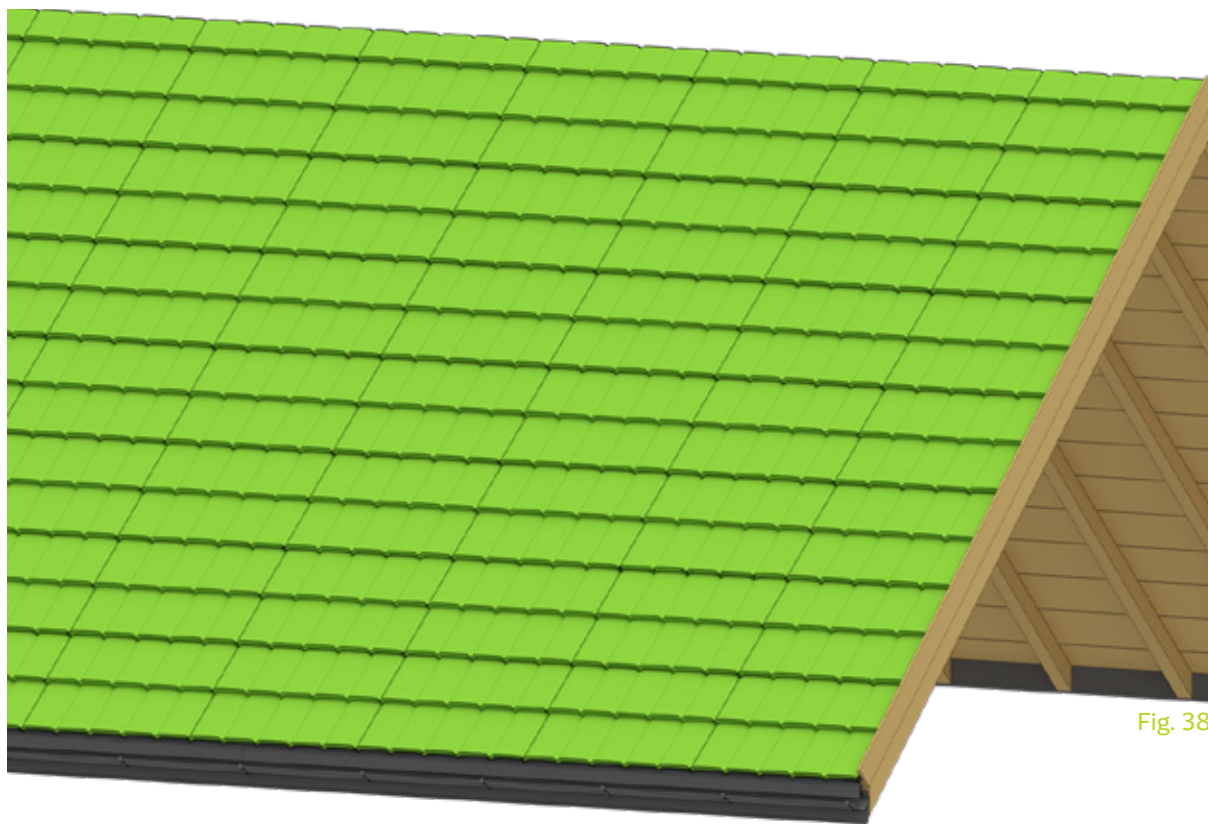

Fig. 38

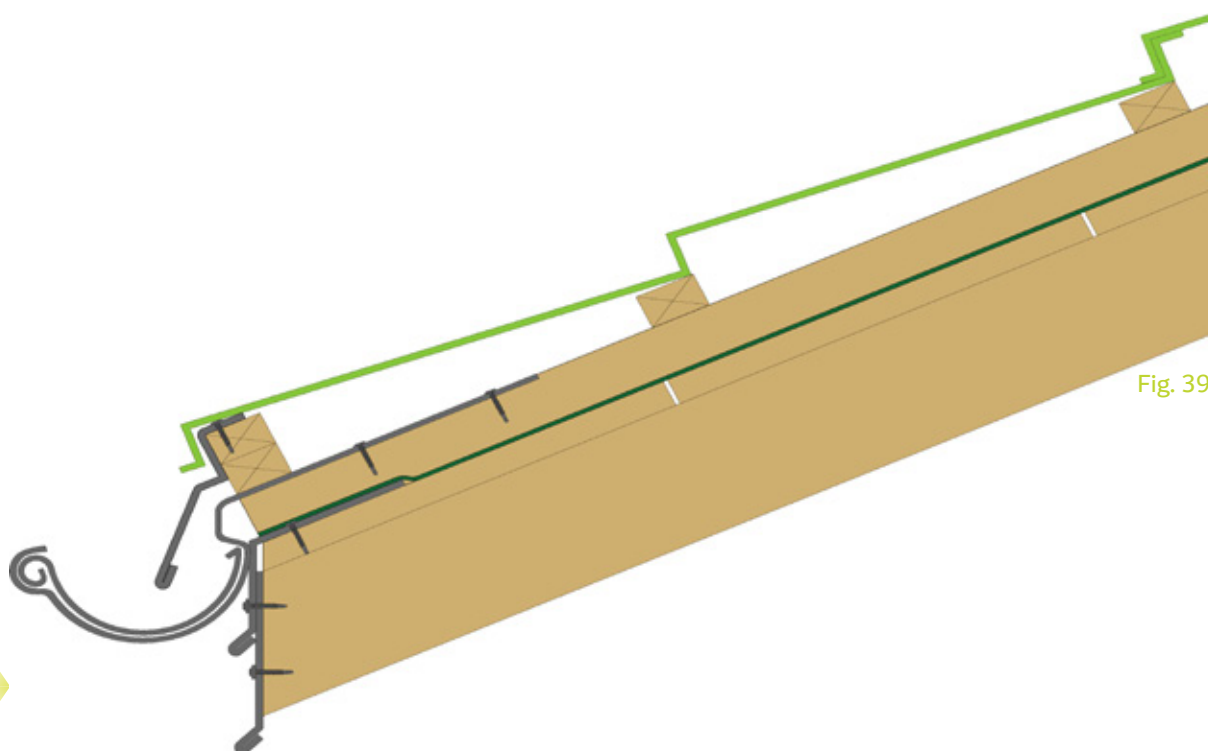

Fig. 39

PLAATSING DAKPLATEN - VARIANT 1 Montage van onder naar boven

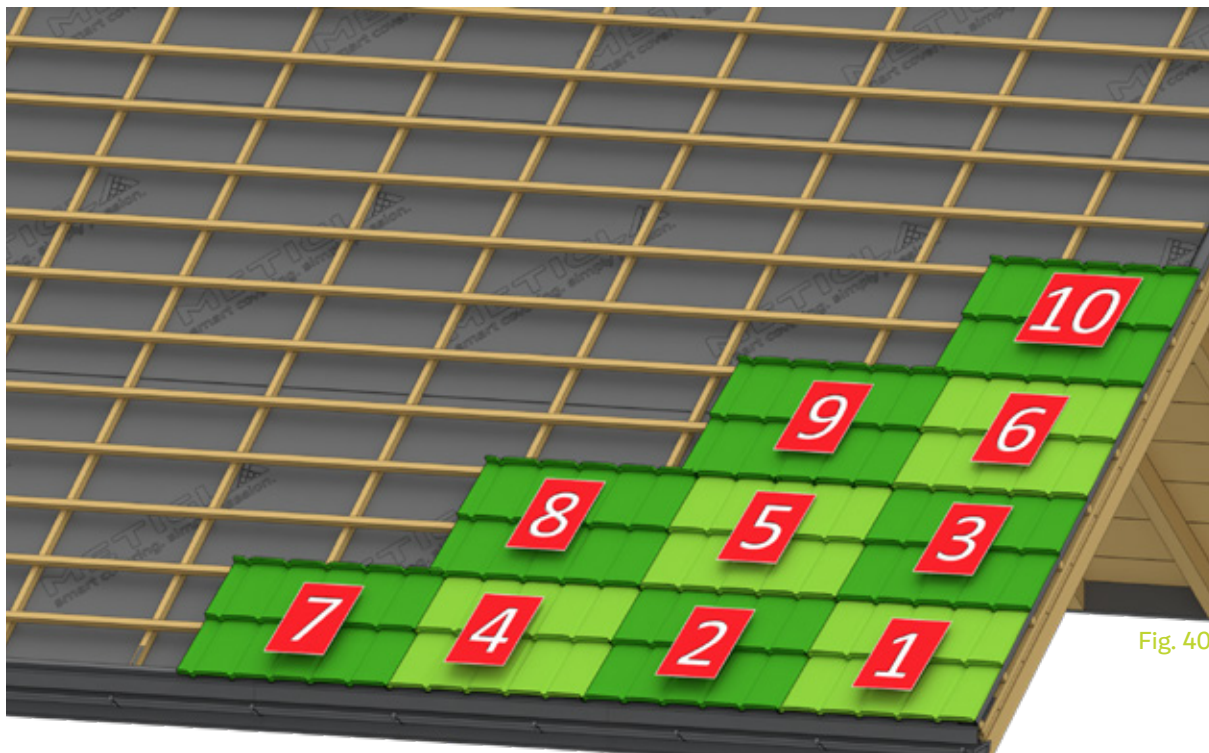

Fig. 40

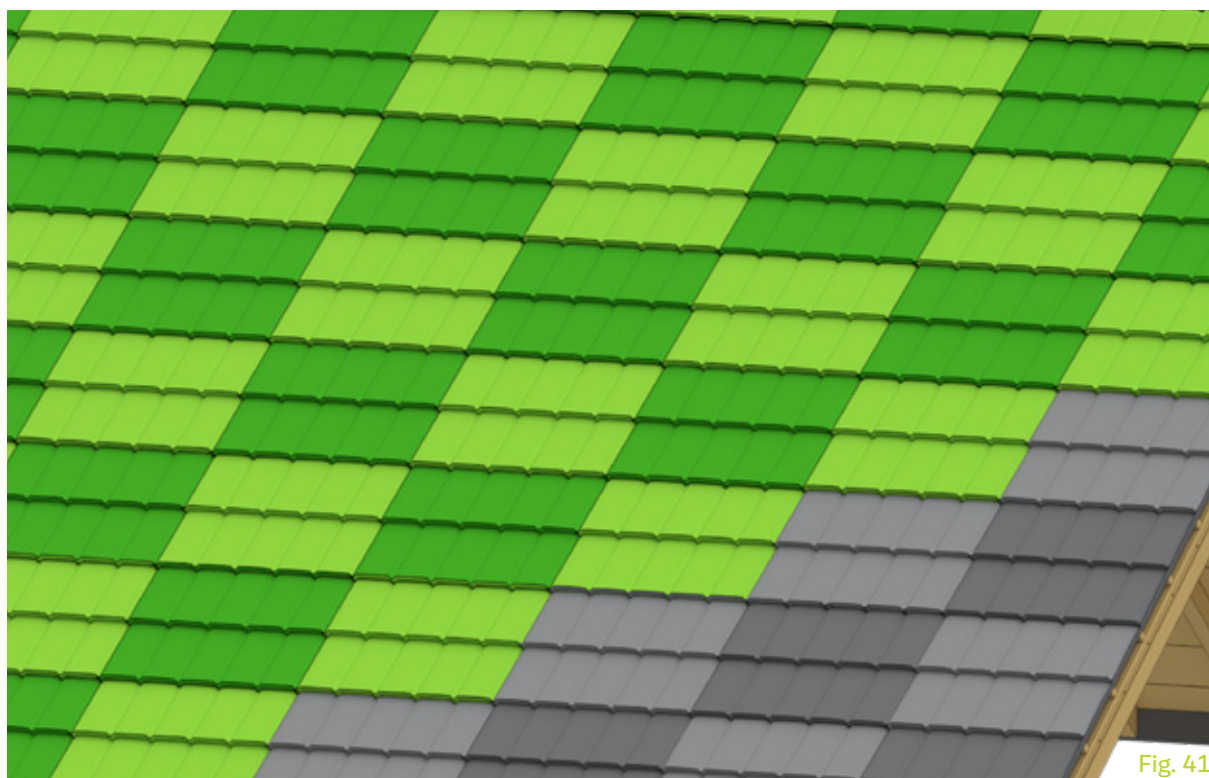

Fig. 41

Correcte overlapping van het SAGA profiel

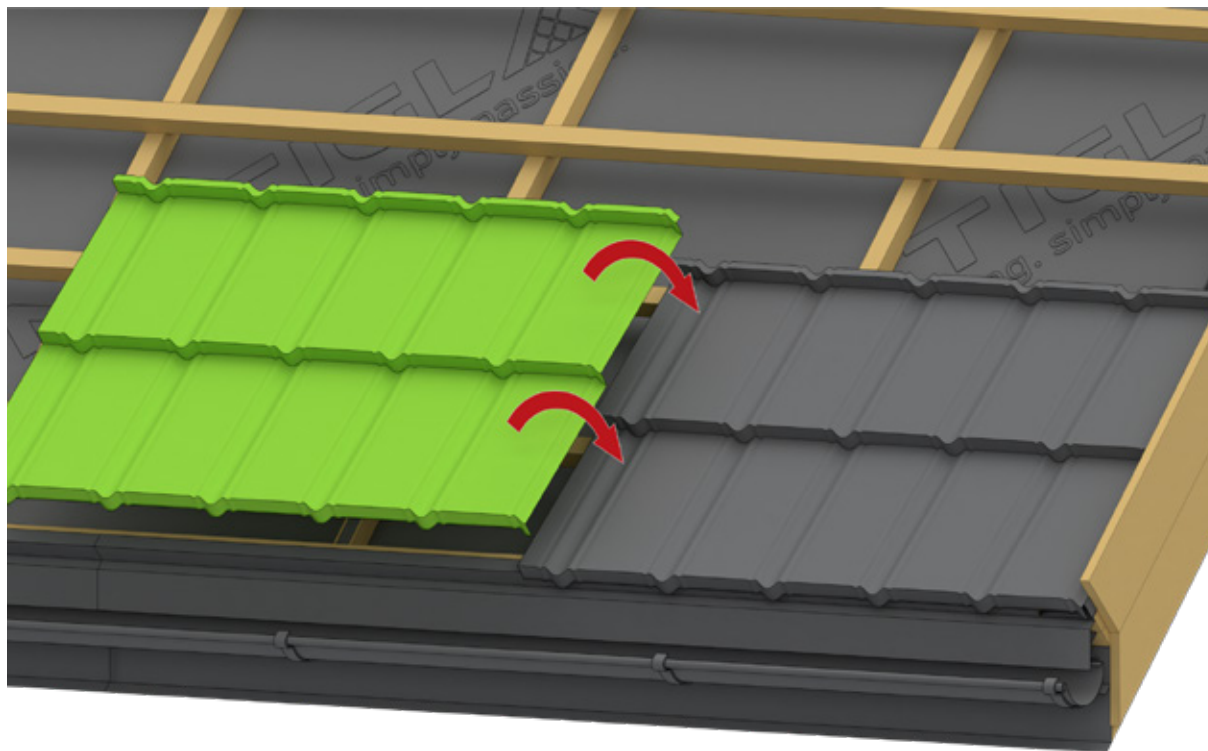

Fig. 42

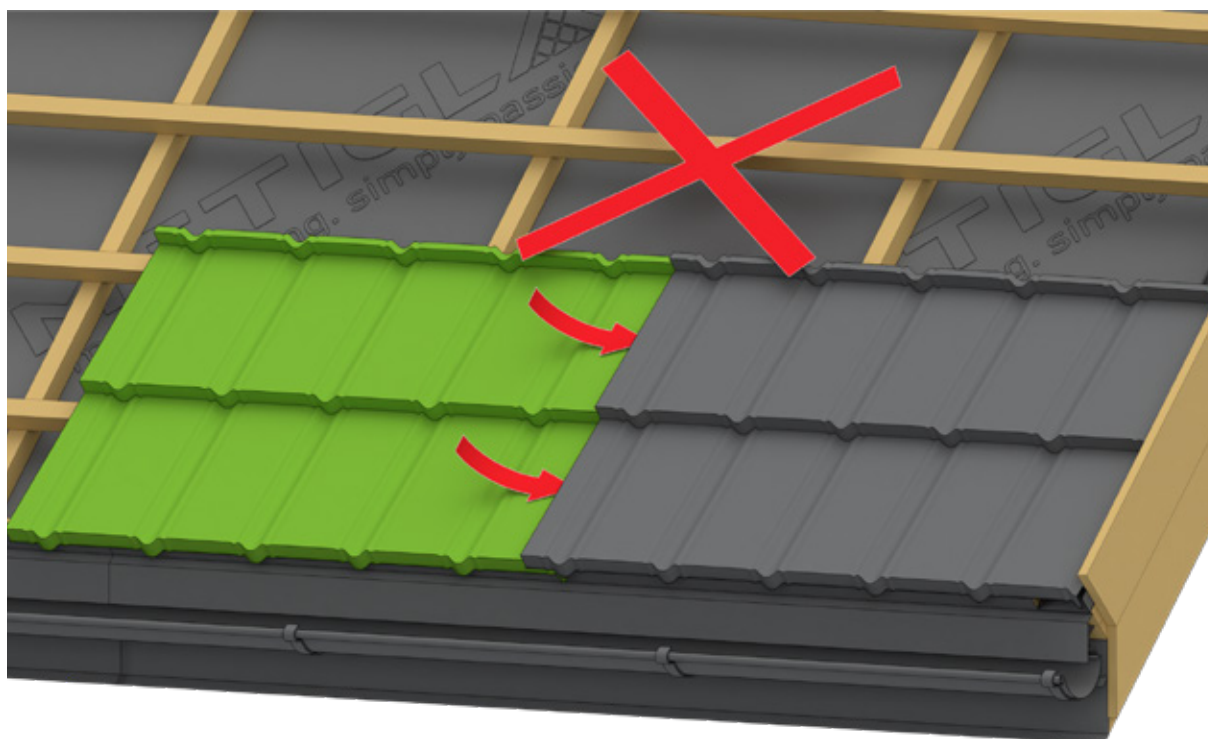

Fig. 43

Correcte installatierichting en overlapping



ELIT



SAGA



STAR



MIRA



PLAATSING DAKPLATEN - VARIANT 2 Montage van boven naar onder

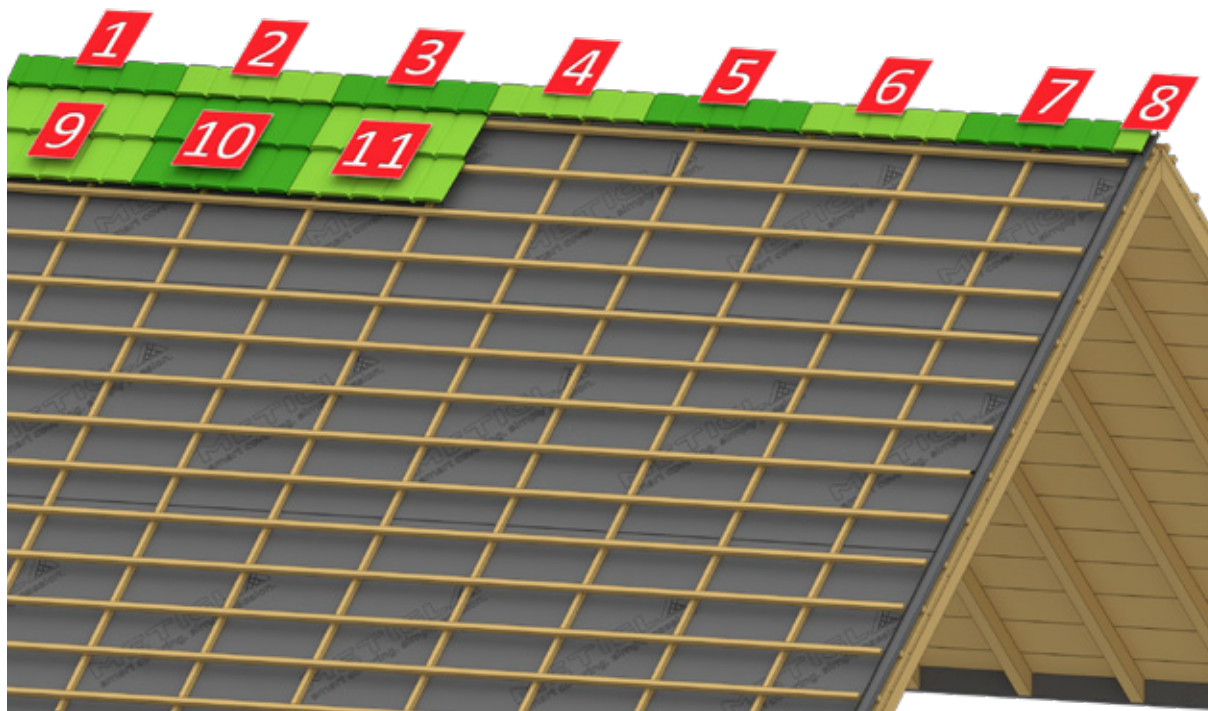

Fig. 44

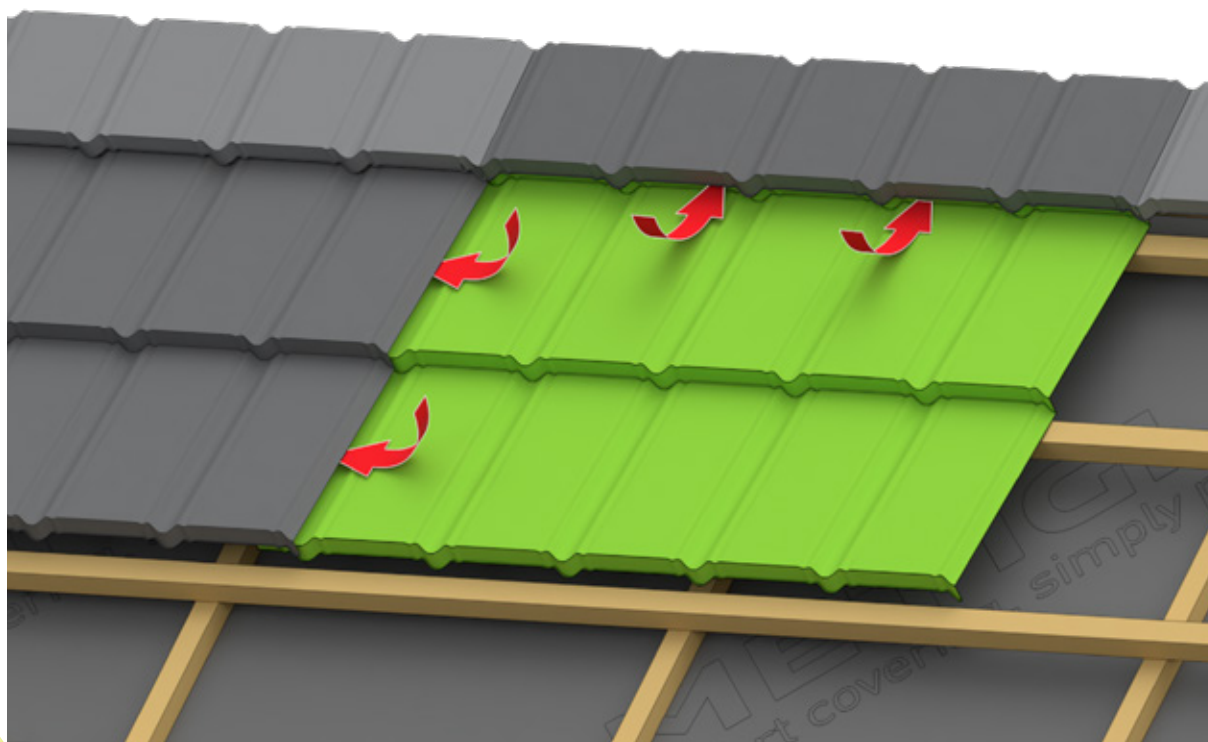

Fig. 45

Correcte plaatsing schroeven

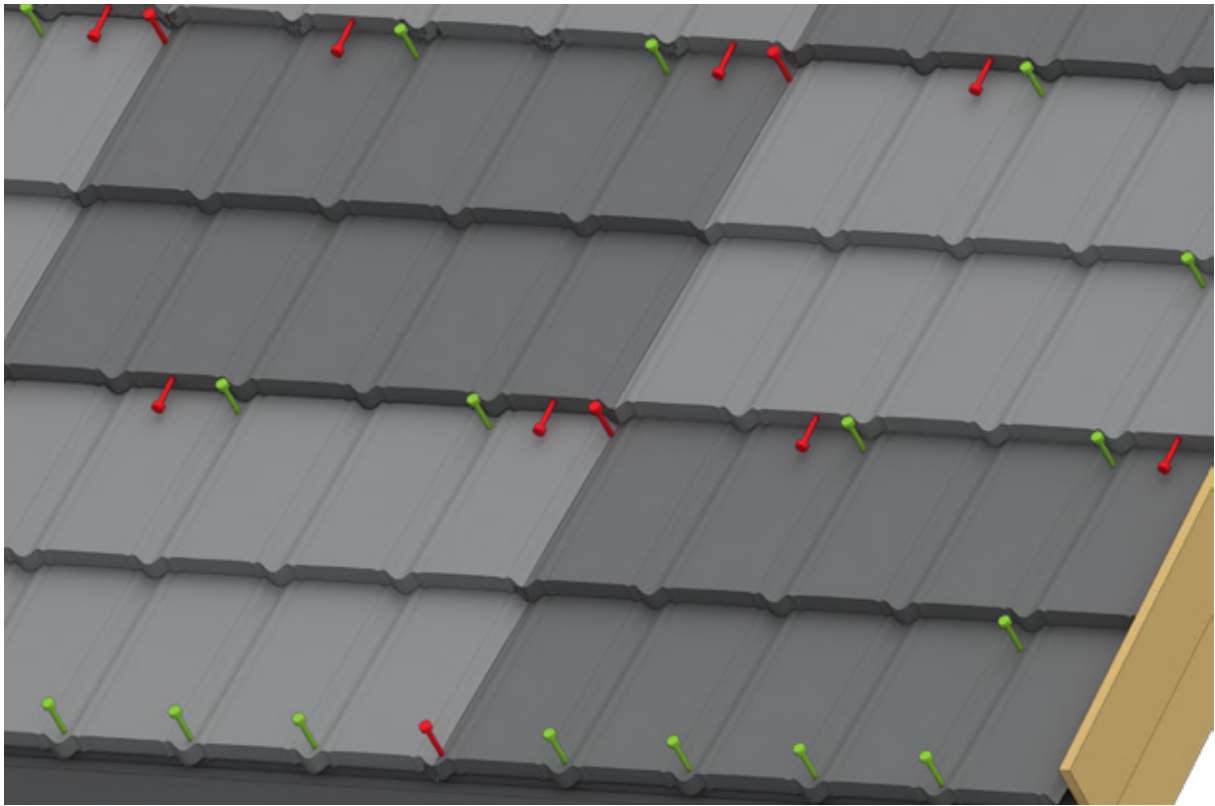

Fig. 46

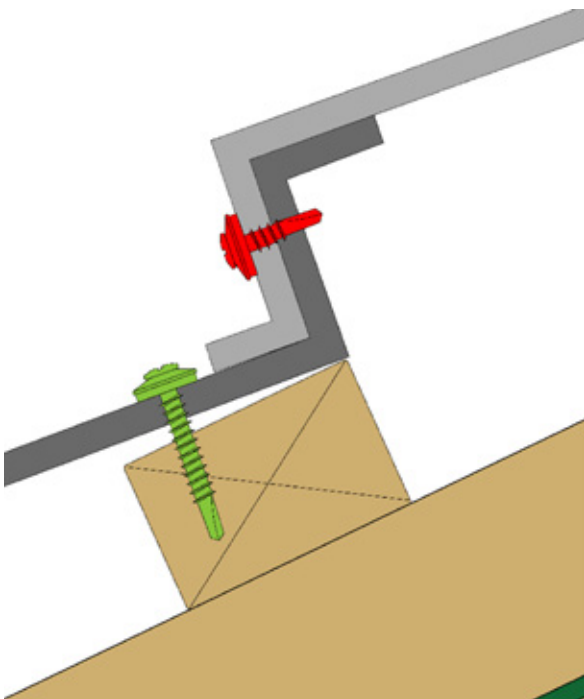

Fig. 47

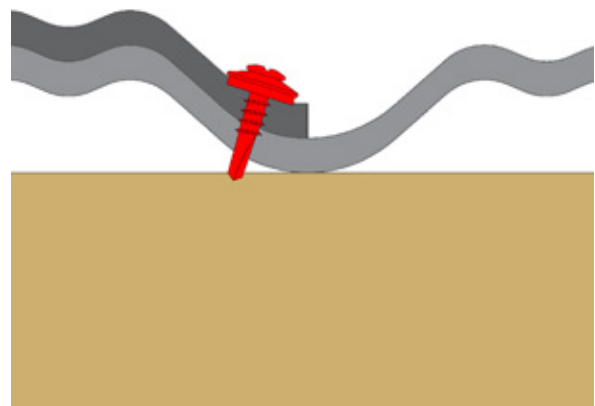

Fig. 48

Plaatsing nokplaat tegen muur

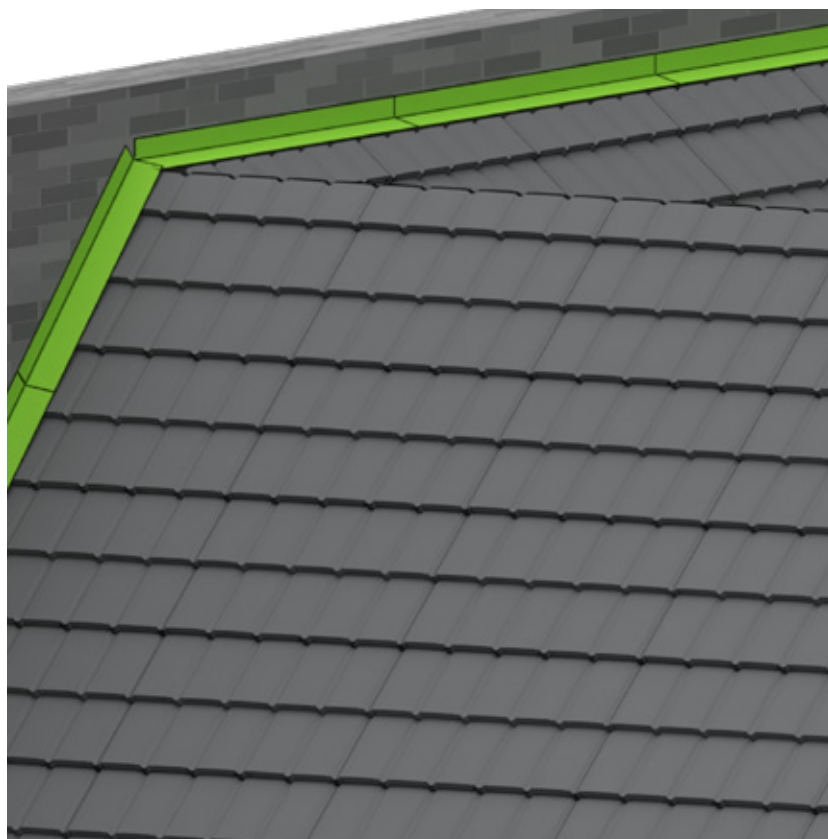
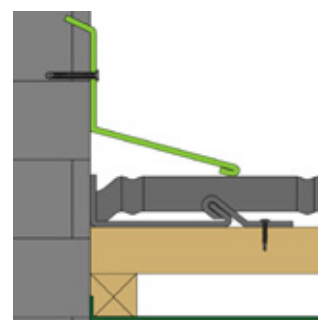

Fig. 49



Montagedetail Fig. 49



Fig. 50

Plaatsing verlenging windveer

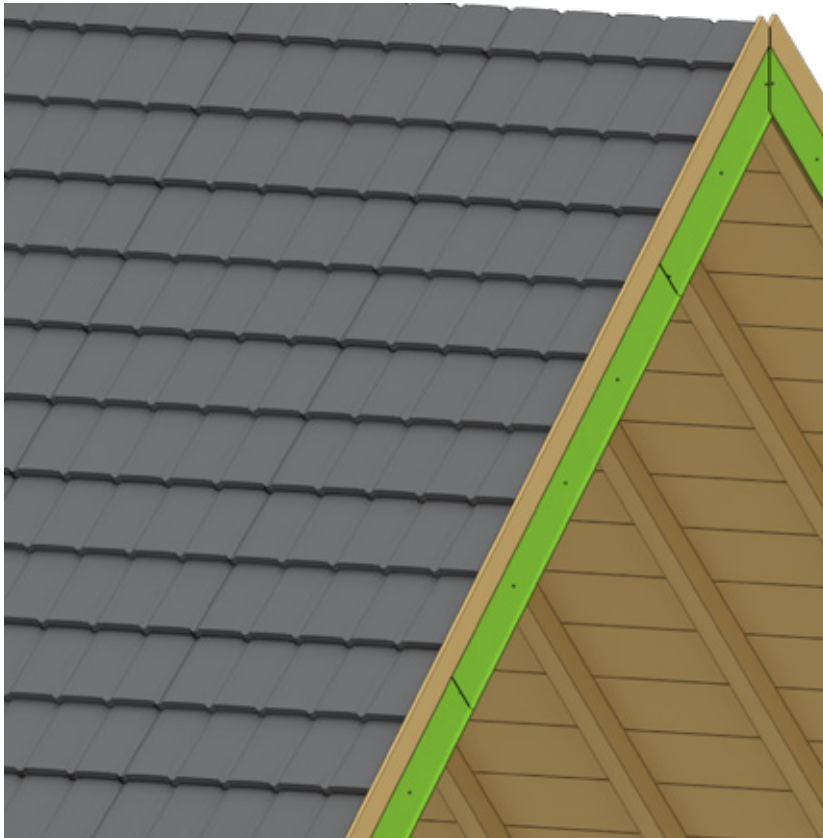
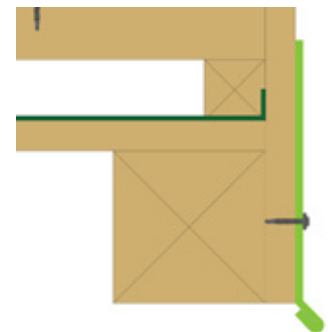

Fig. 51



Montagedetail Fig. 51

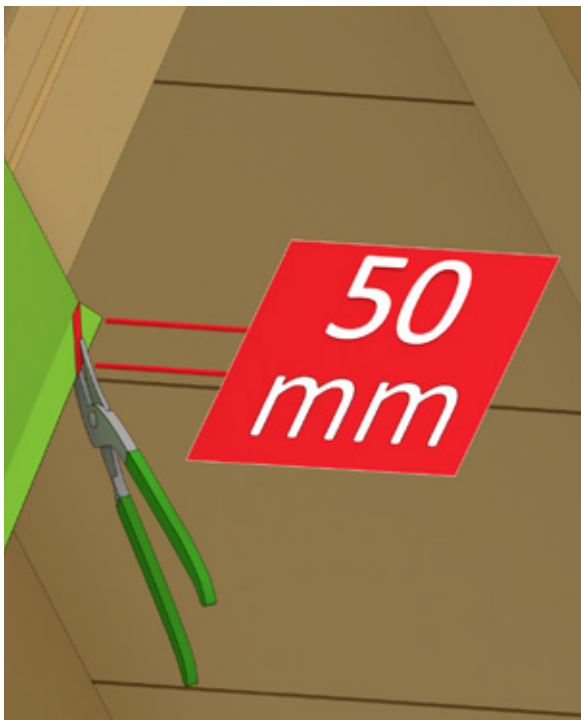

Fig. 52

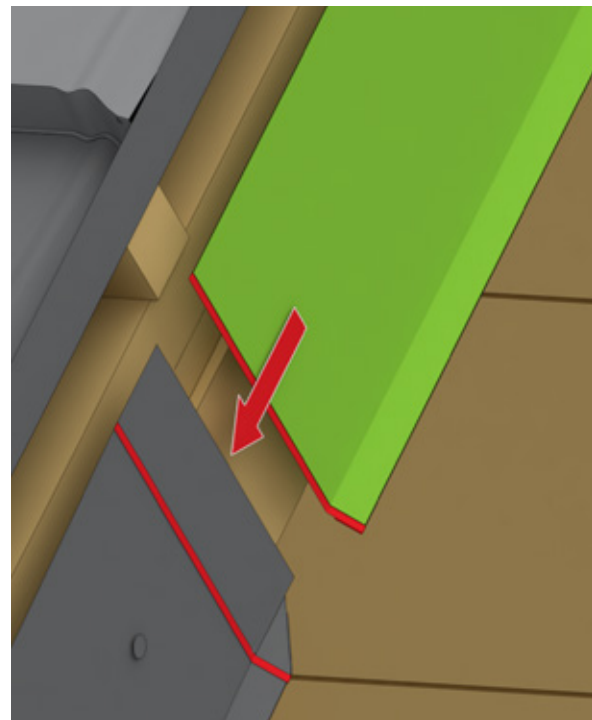

Fig. 53

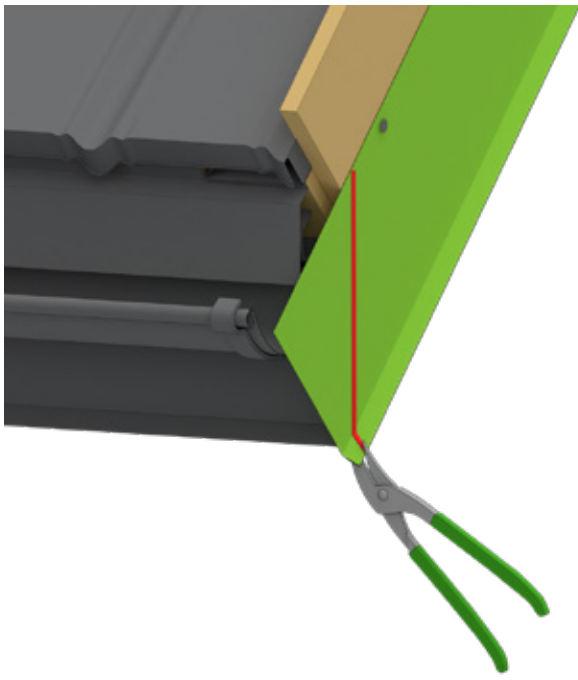

Fig. 54

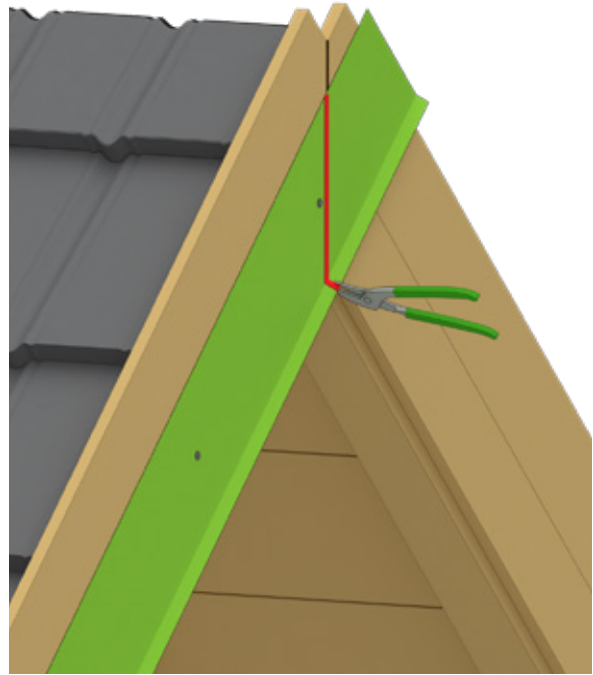

Fig. 55

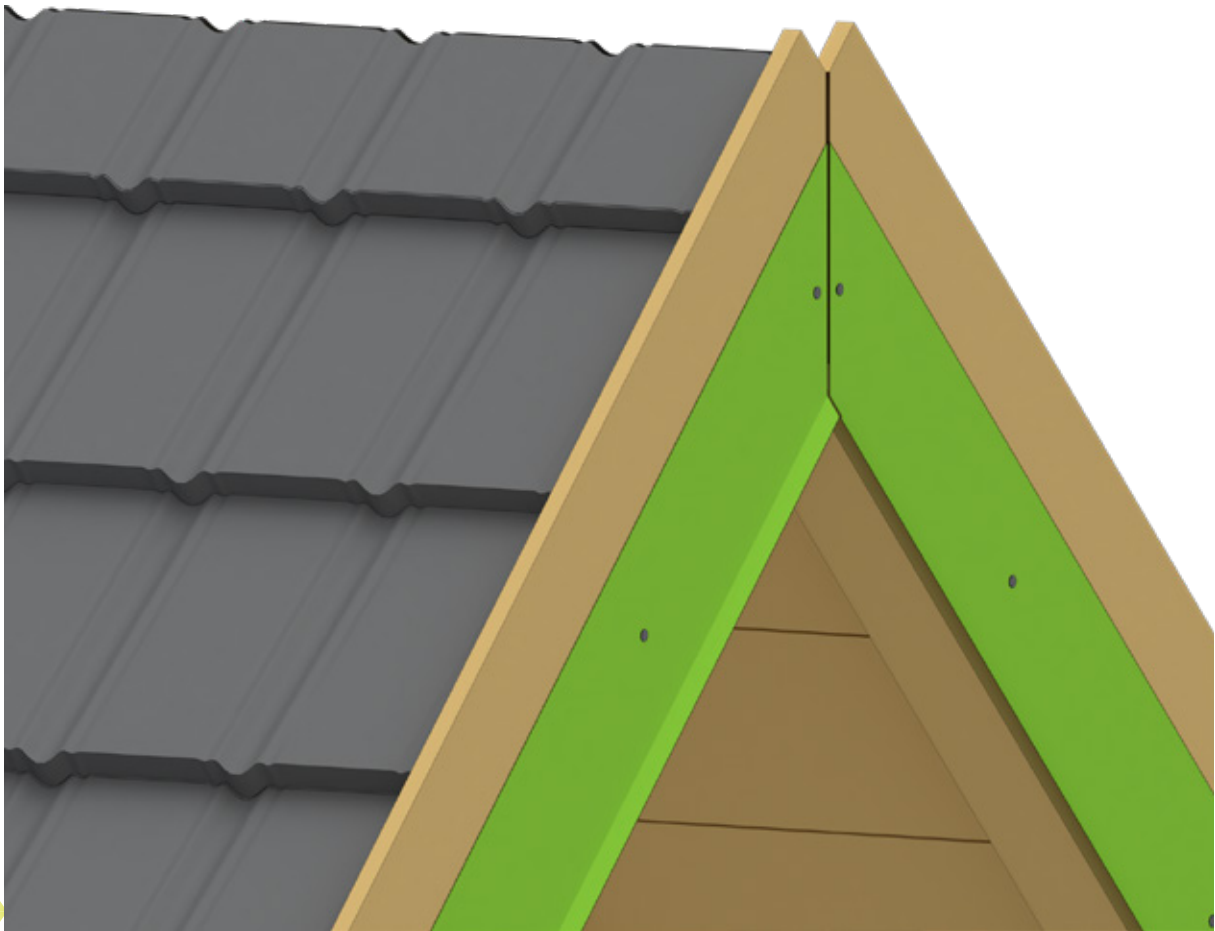

Fig. 56

Plaatsing windveer

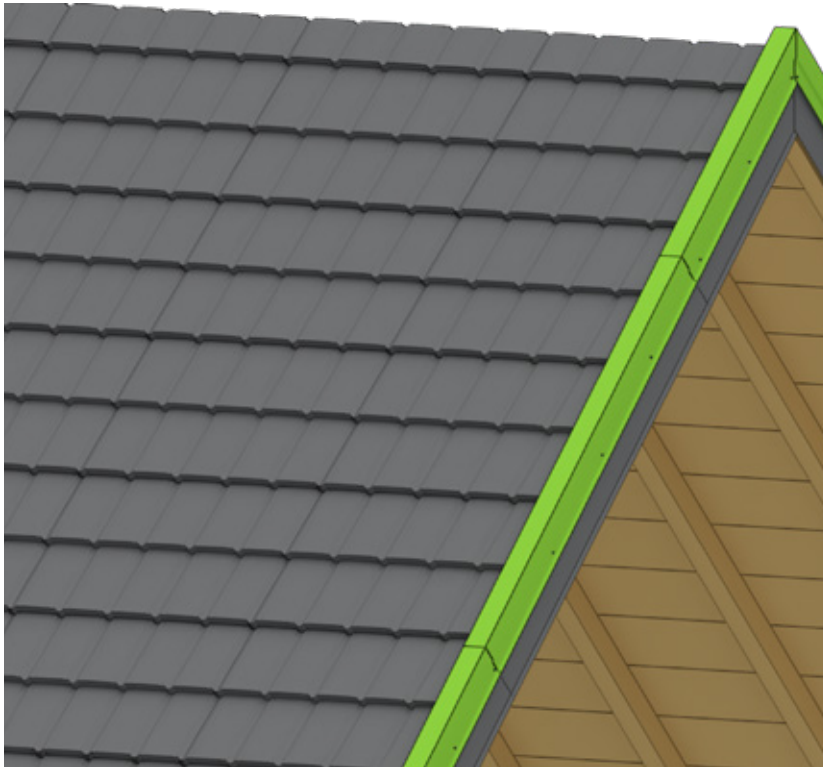
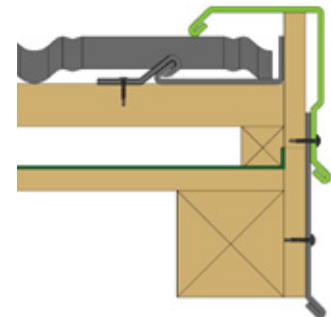

Fig. 57



Montagedetail Fig. 57

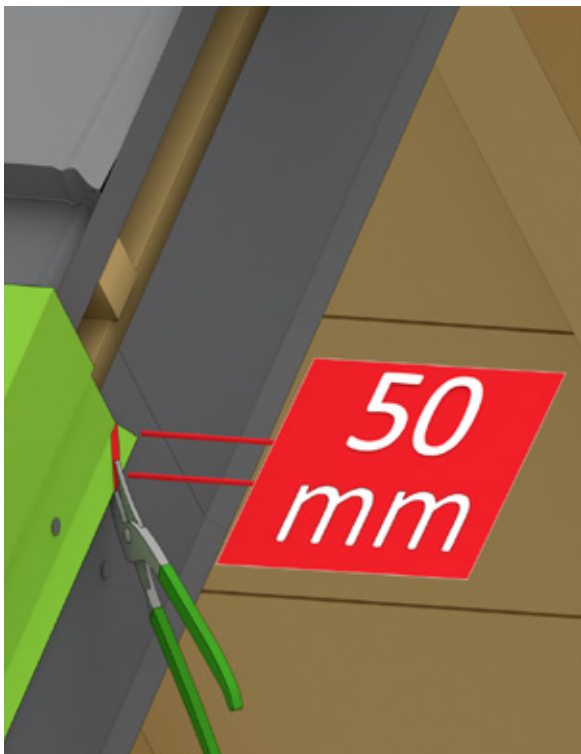

Fig. 58

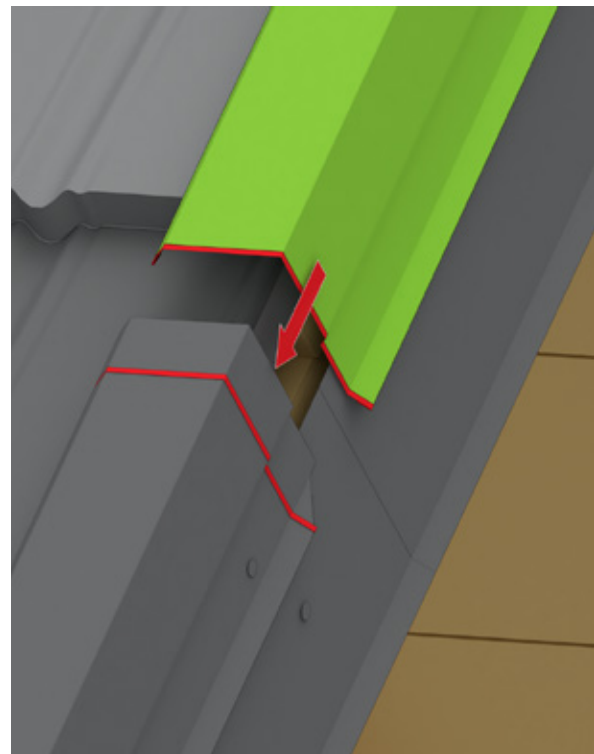

Fig. 59

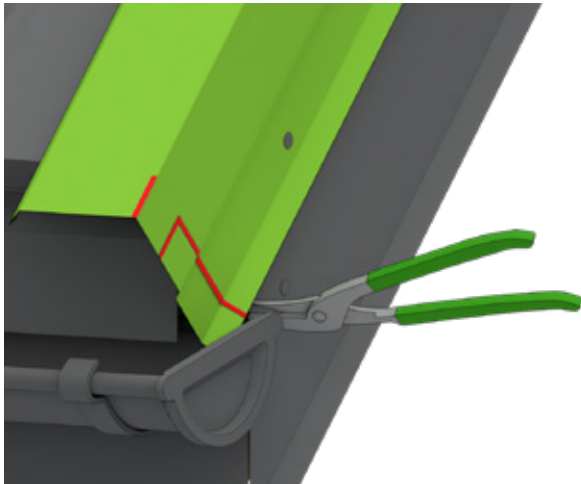

Fig. 60

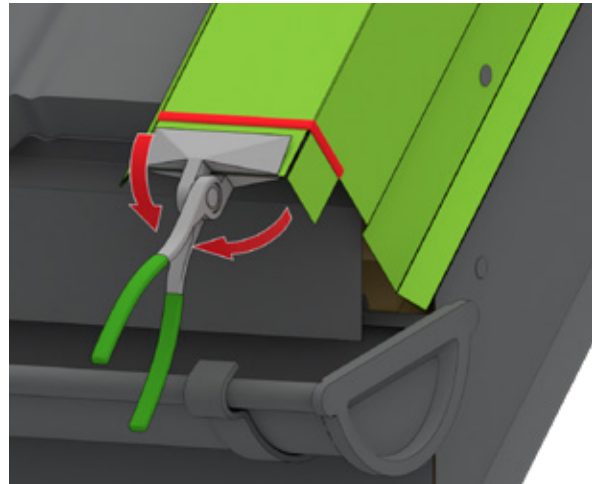

Fig. 61

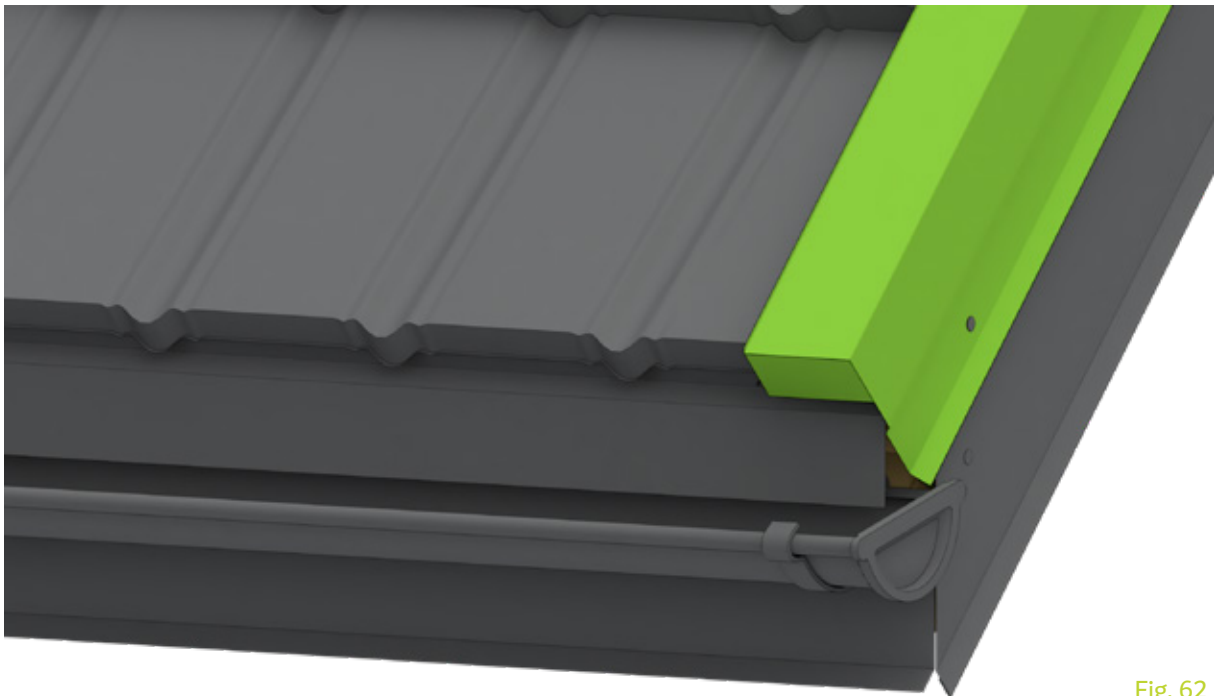

Fig. 62



Fig. 63



Fig. 64

Plaatsing ondernok

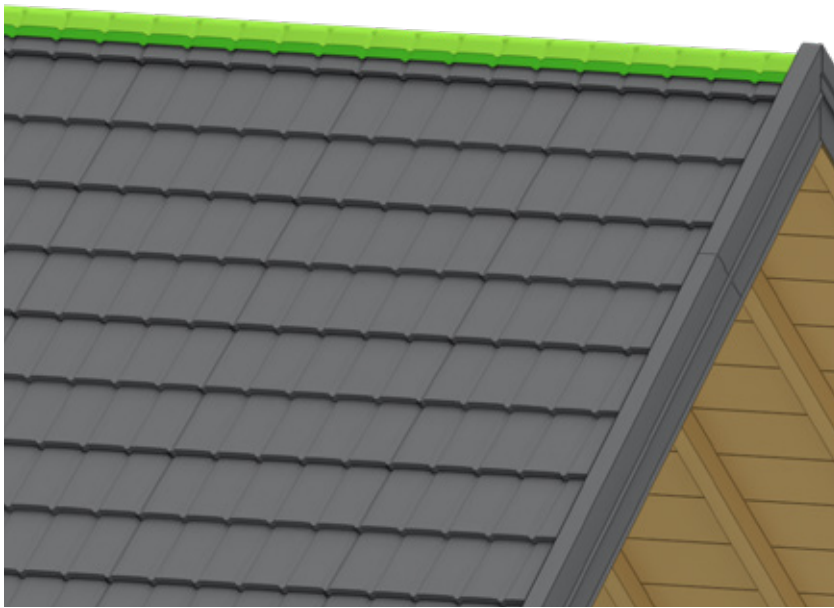
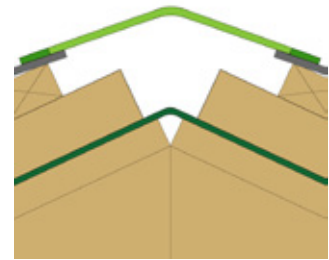

Fig. 65



Montagedetail Fig. 65

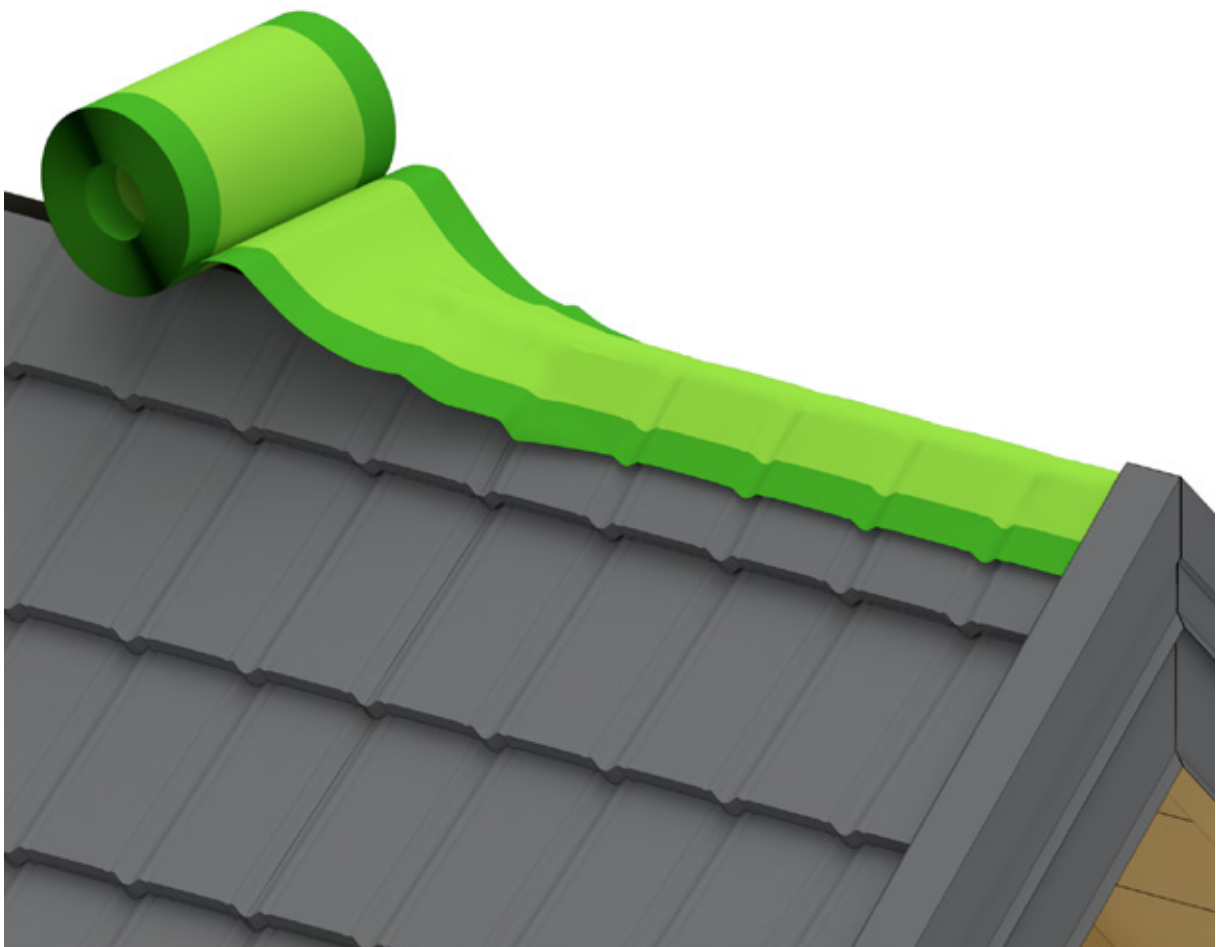

Fig. 66

Plaatsing nok

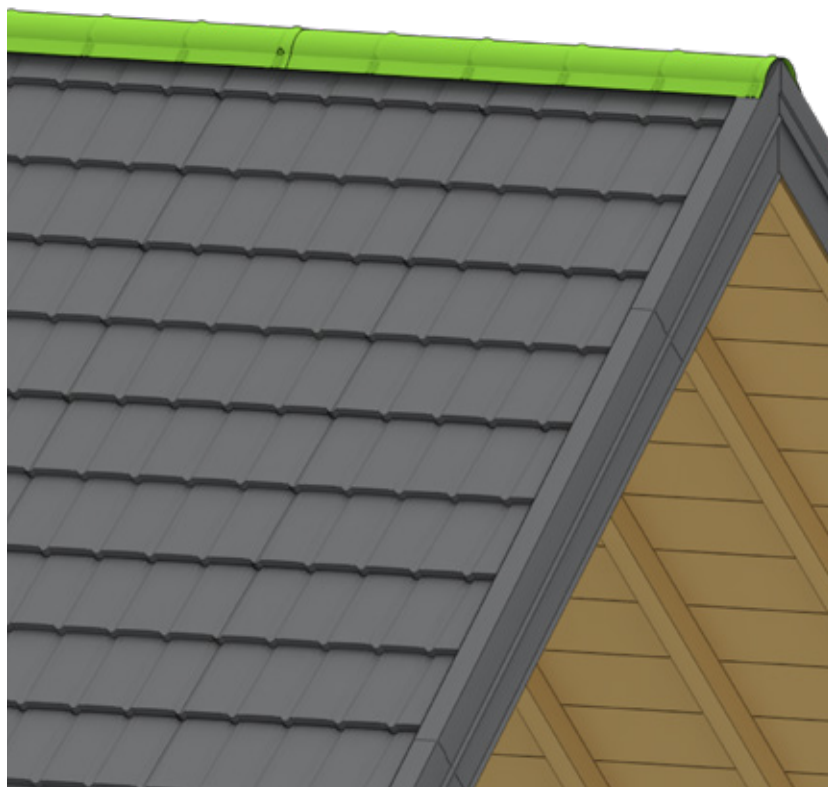
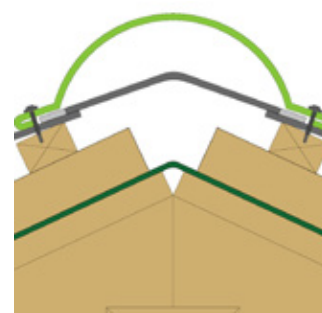

Fig. 67



Montagedetail Fig. 67



Fig. 68

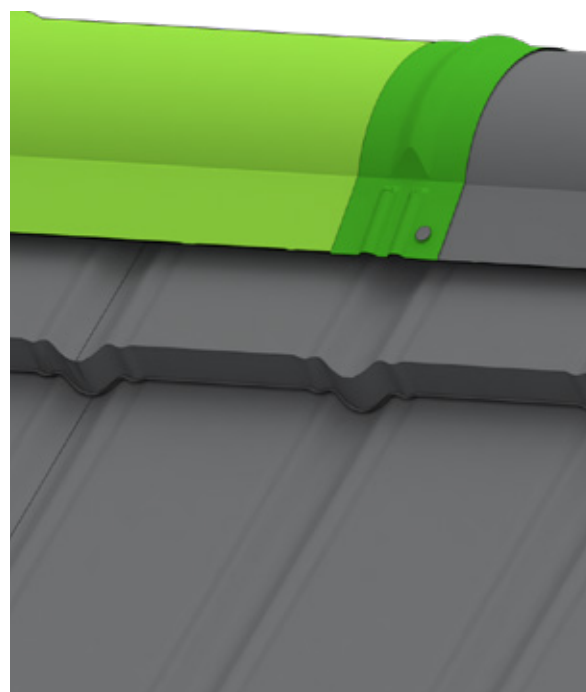

Fig. 69

Plaatsing nokafsluiting

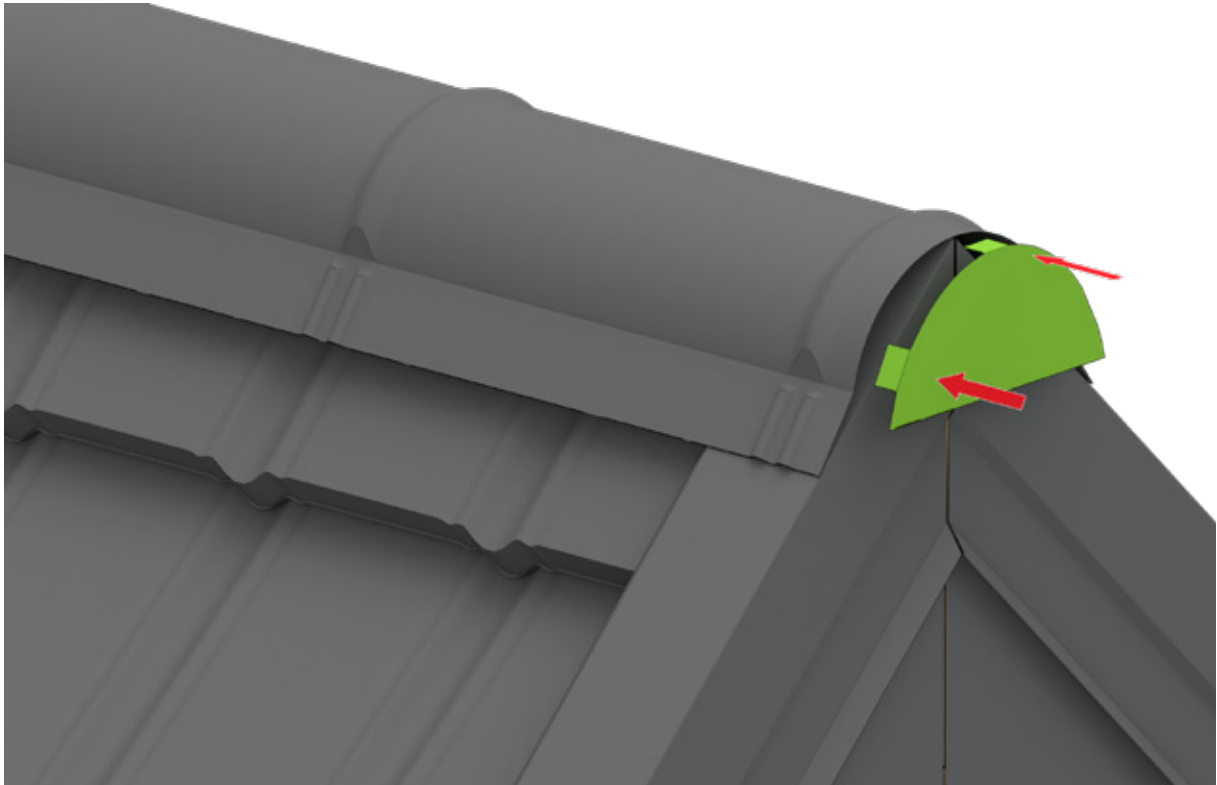

Fig. 70

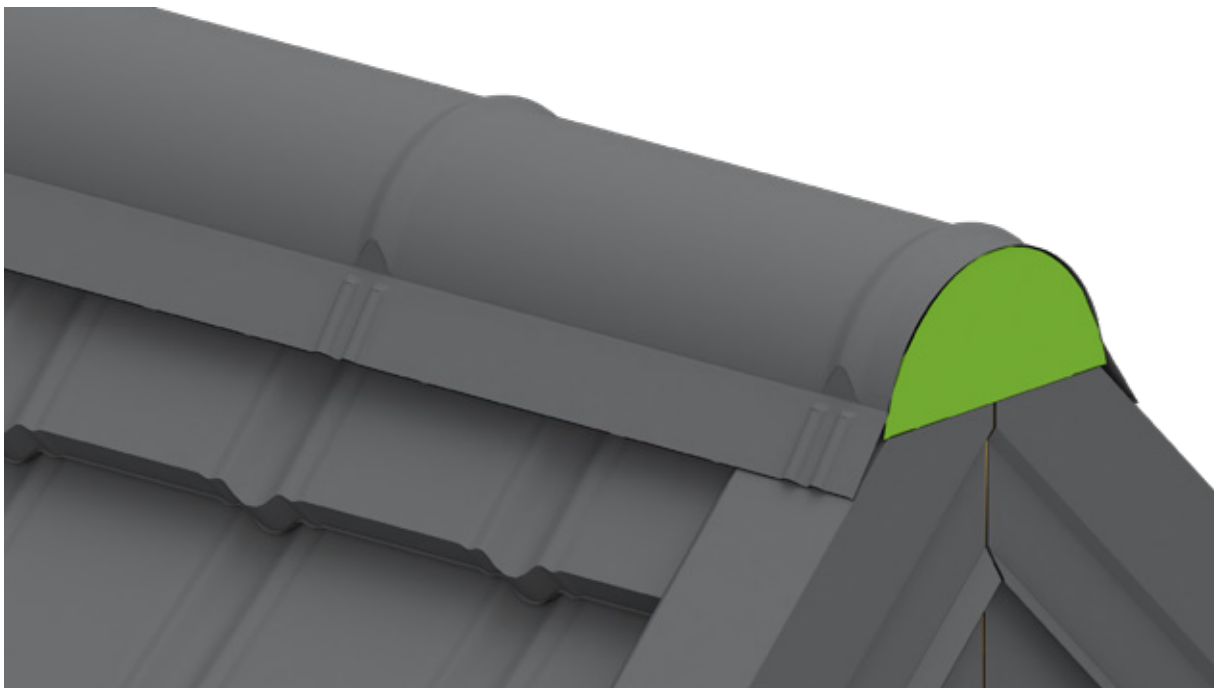

Fig. 71

Plaatsing sneeuwstoppers

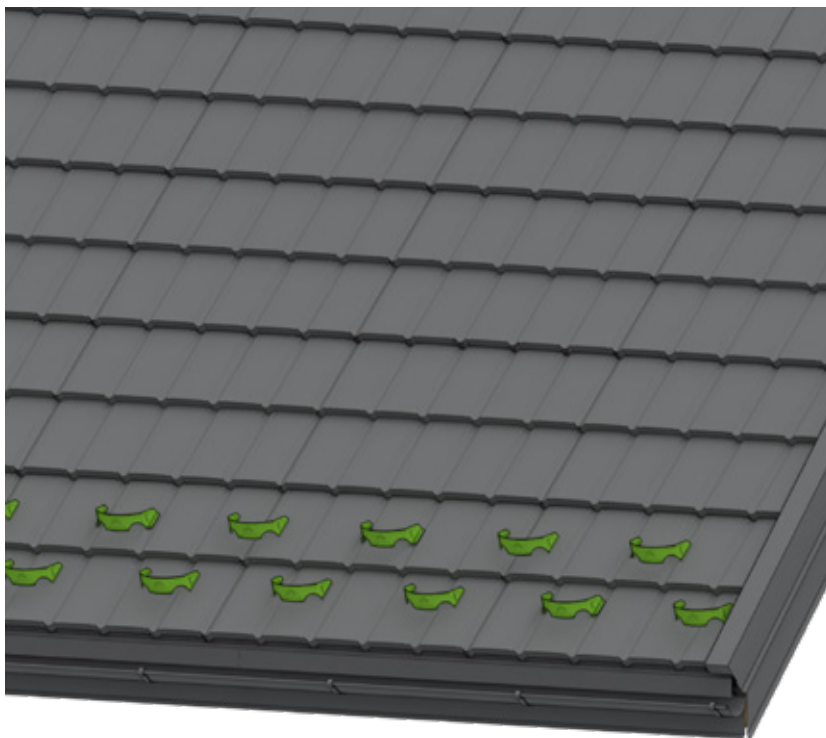

Fig. 72



Montagedetail Fig. 72

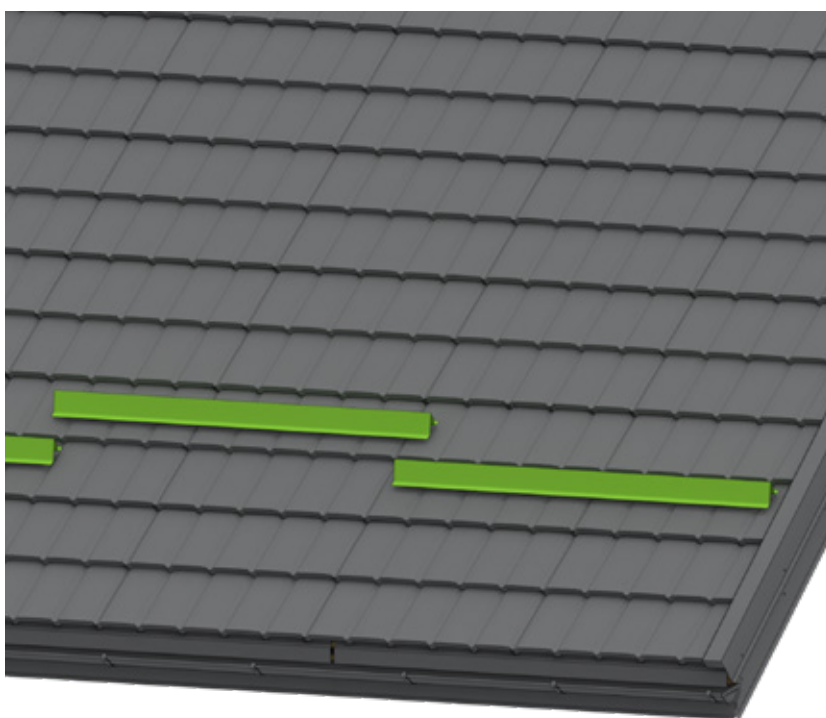
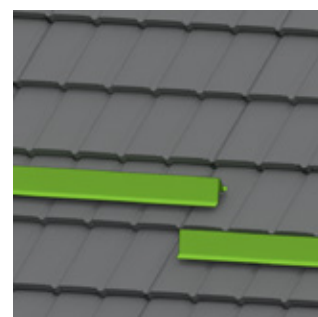

Fig. 73



Montagedetail Fig. 73

Palletisering en opslag

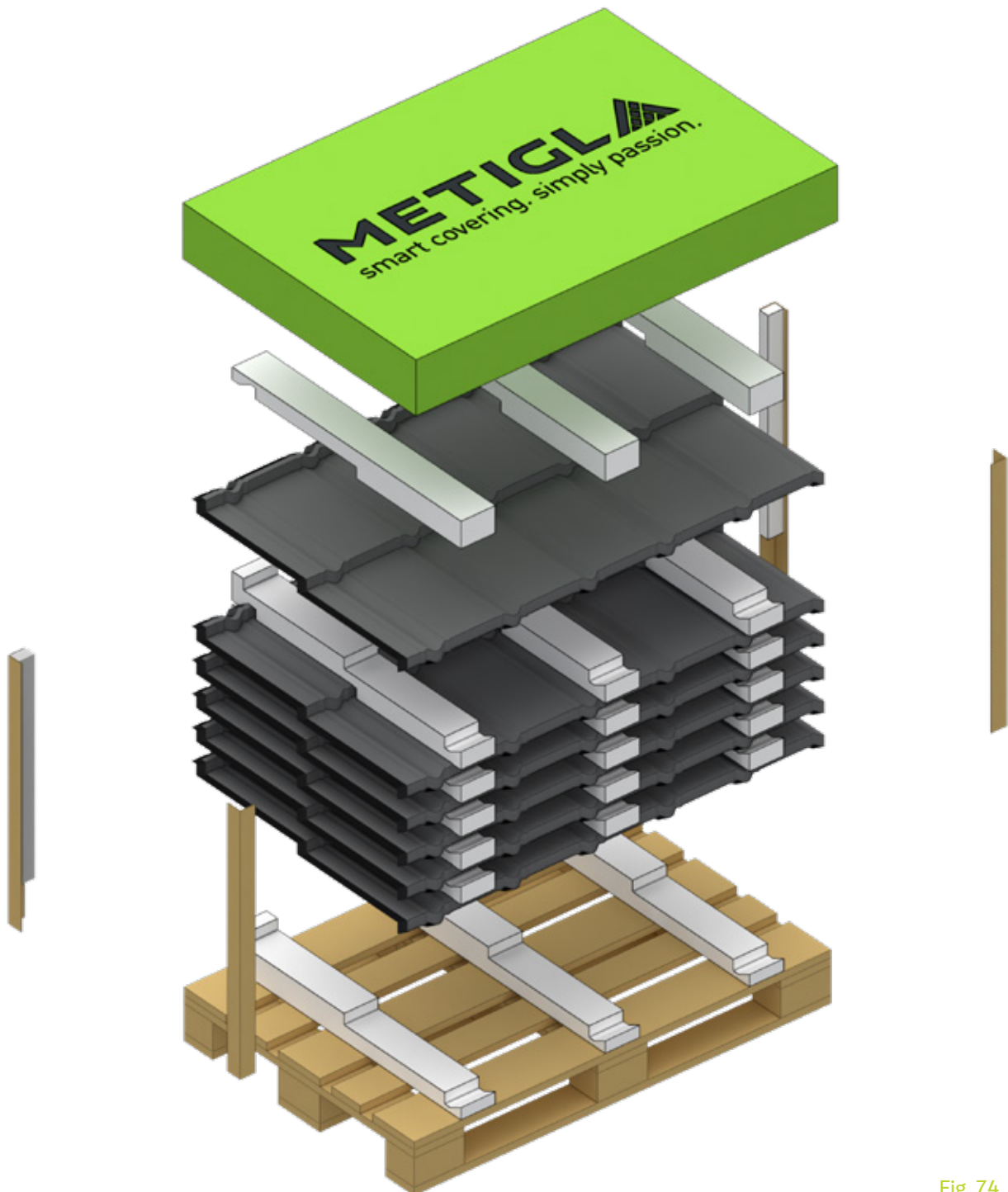
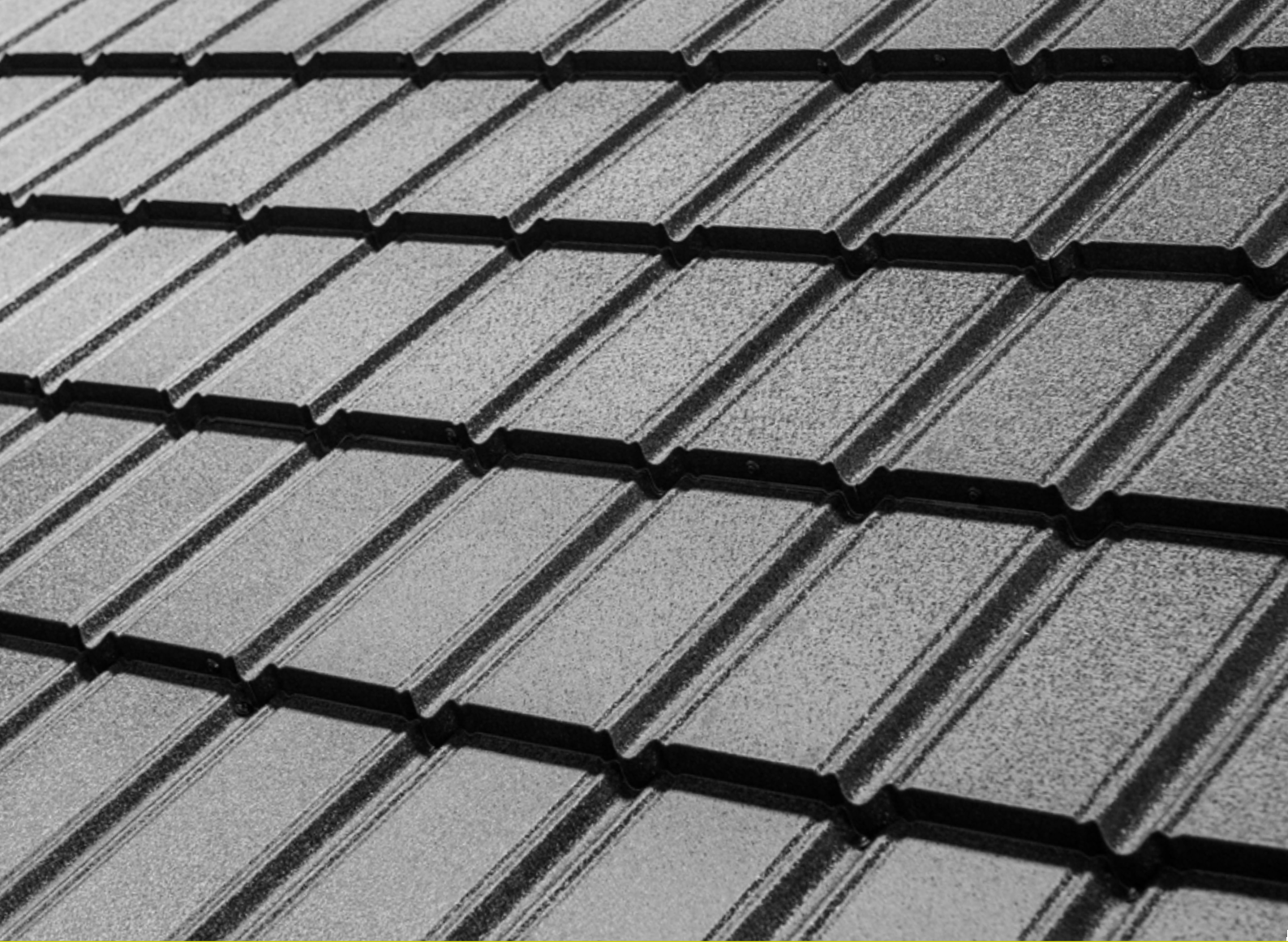

Fig. 74



smart covering.
simply passion.

METIGLA
smart covering. simply passion.

Metigla SRL
Ceptura, Prahova,
107126, Roemenië
T +40 244 44 58 00
F +40 244 44 58 01

metigla.ro

Metigla SA
Villers-le-Bouillet,
4530, België
T +32 42 50 12 08
F +32 43 80 17 66

metigla.be

Ediția 1/2023
MM-R-TMM-0-RO Rev.0 2023